

The logo consists of the letters 'D' and 'M' in a stylized, red, serif font, positioned one above the other within a white square background.

DECOMASTER

БАГЕТ



БАГЕТ

ДЕТАЛИ КАЖДОЙ СОВЕРШЕНСТВО

Компания DECOMASTER более 20 лет работает на российском рынке элементов оформления интерьера и отделочных материалов. За это время мы зарекомендовали себя в качестве производителя высокотехнологичных трендовых изделий и эксперта в области комплексных интерьерных решений. Сегодня мы предлагаем Вашему вниманию богатую коллекцию рамного багета.

Багет DECOMASTER производится из экологически чистого материала – полистирола высокой плотности. Этот современный материал не деформируется со временем, не дает усадки, не впитывает запахи и не боится влажности.

Палитра багетов DECOMASTER отличается широким разнообразием и может служить неисчерпаемым источником вдохновения. Здесь Вы найдете как благородные классические оттенки серебра, золота, бронзы и дерева, так и современные цветовые решения. Вы сможете подобрать багет различных стилистических направлений: и старинные рамы различных эпох, и рамы в стилях кантри, модерн, техно и других для воплощения любых идей в оформлении пространства.

Большой выбор форм, цветов и размеров позволяет применять багет не только для традиционного оформления картин, зеркал, вышивок и фотографий. Современным трендом является смешение стилей и использование нешаблонных дизайнерских приемов. Багет DECOMASTER можно применить для обрамления практически любой детали интерьера, требующей завершения, – декорировать красивой багетной рамой телевизор, аквариум, художественную вставку на обоях или подчеркнуть сочетание разных оттенков декоративной штукатурки, стеновых панелей. Можно украсить двери, предметы мебели или кессонный потолок, сделать оригинальные карнизы для штор.

Багет DECOMASTER придаст изысканности и элегантности, позволит добавить тот самый финальный штрих, который сделает Ваш интерьер уникальным.





947-565

947-566

947-954

947-956

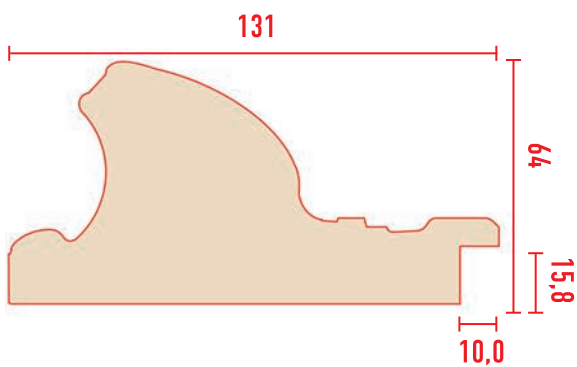



S16-1223



S16-966

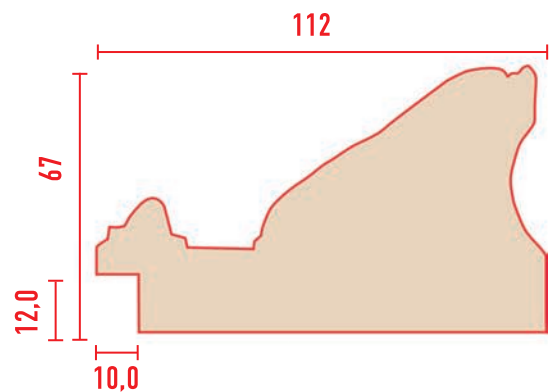



230-966

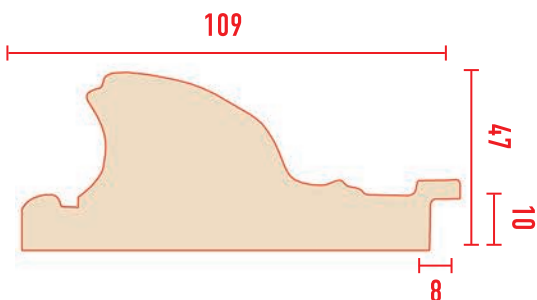

230-1223



230-1543 **NEW**



230-1604B **NEW**



230-1605B **NEW**



230-1610 **NEW**



230-70 **NEW**



980-566



980-565

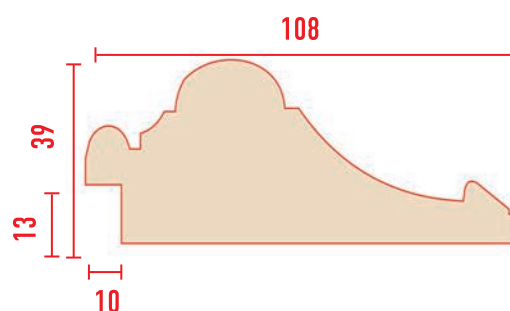



229-1223



229-966



229-645



229-955

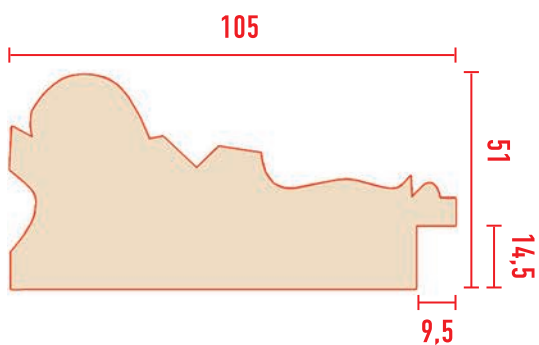



229-1068

229-182

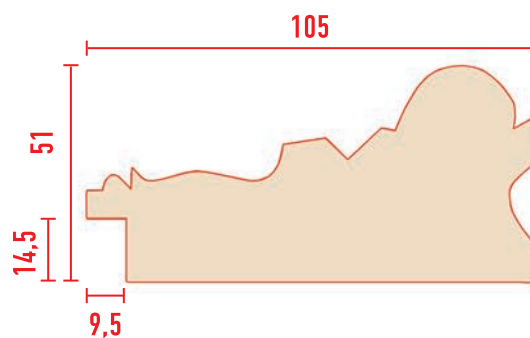



400-958

400-954

400-956

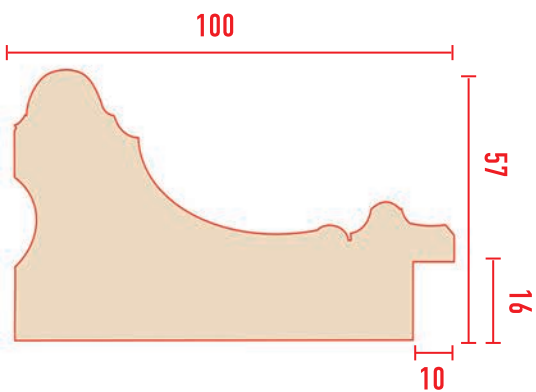

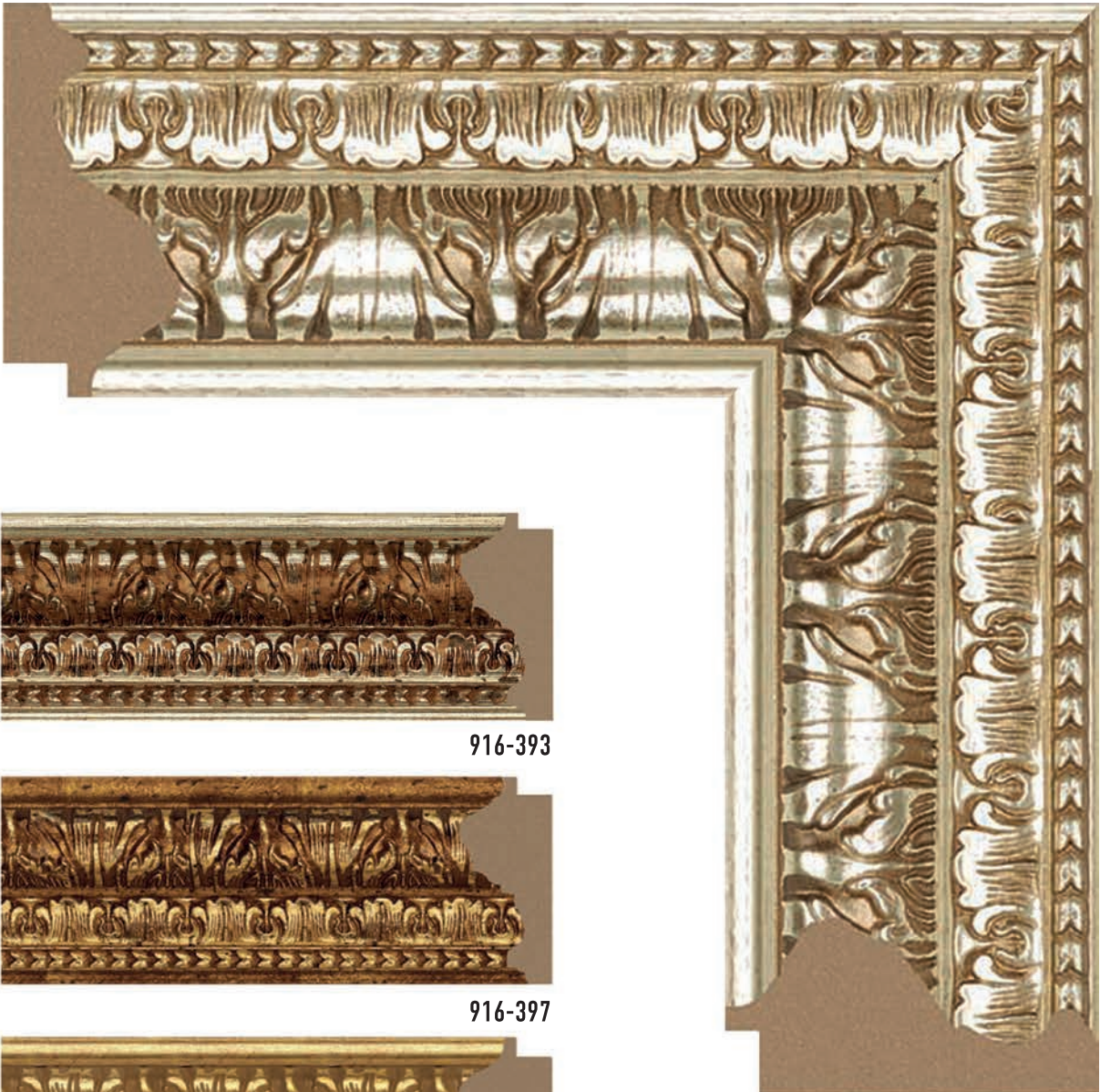

916-247



916-393



916-397



916-461

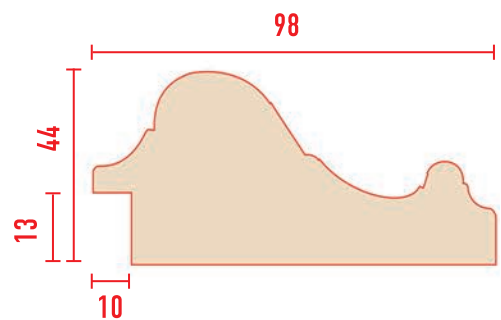



214-3



214-373



214-6

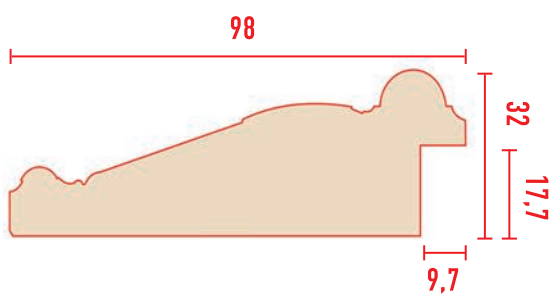

STANDARD



NEW S26-1604B



NEW S26-1605B



NEW S26-70

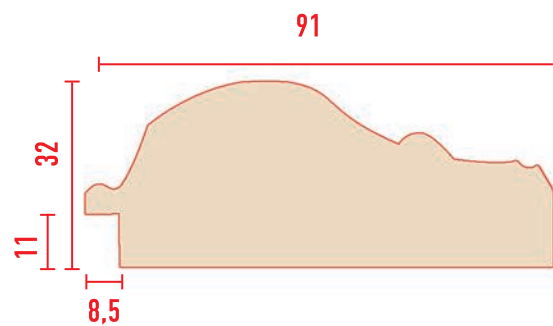



413-566



413-565



413-494



413-919



413-182





413-1607 **NEW**



413-1608 **NEW**



413-1609 **NEW**

NEW 413-1606

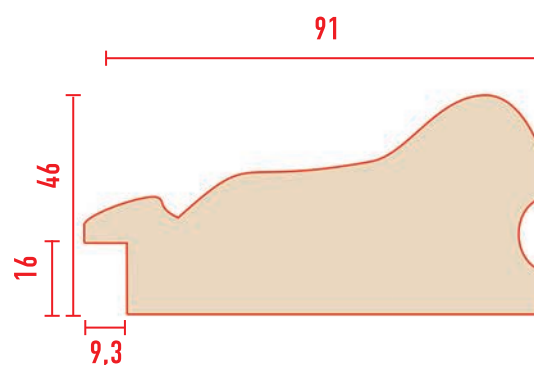



927-252

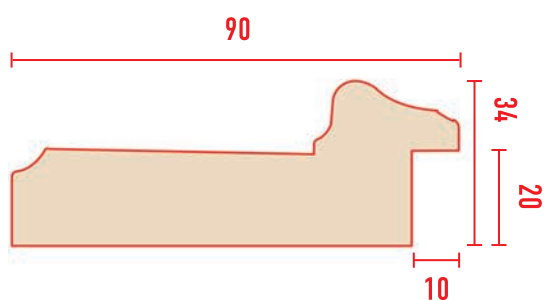



849-919





849-566

849-565

849-373

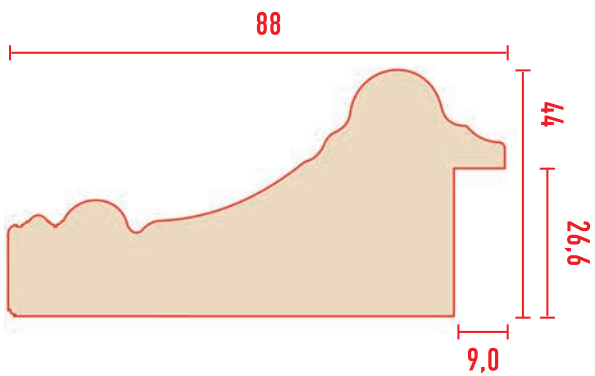



868-645

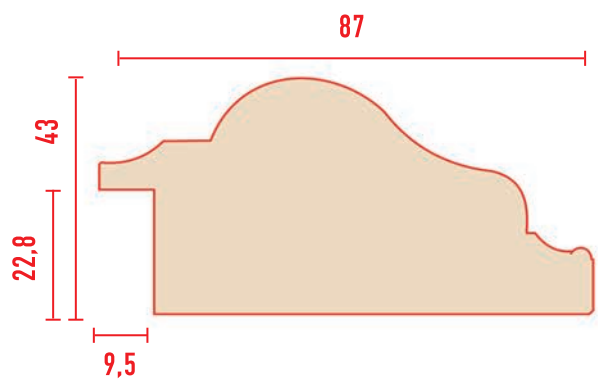



516-1069



516-1333

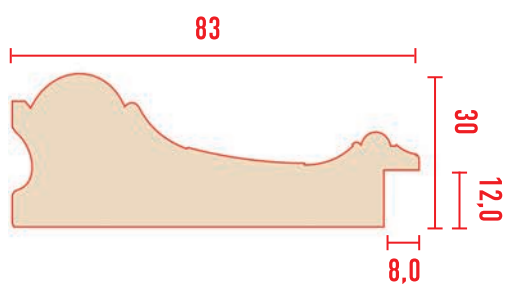



516-767



516-127



516-1070

516-126

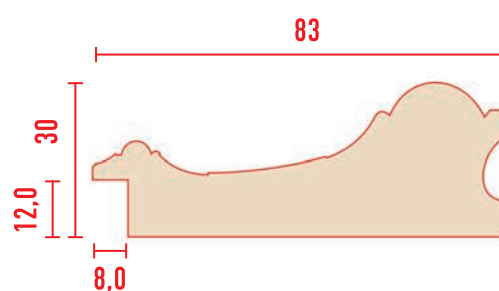



552-195



552-114



552-373



552-1153

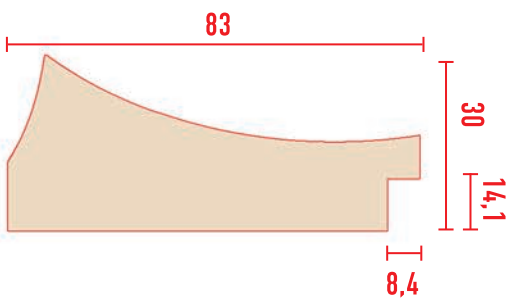



NEW 552B-1607



NEW 552B-1608



NEW 552B-1609

NEW 552B-1606

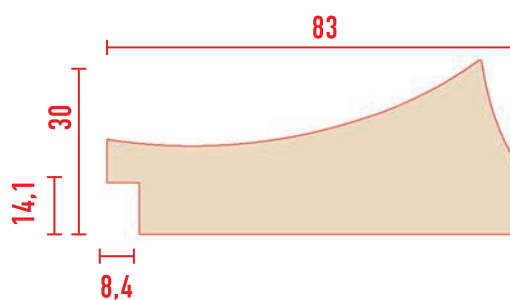

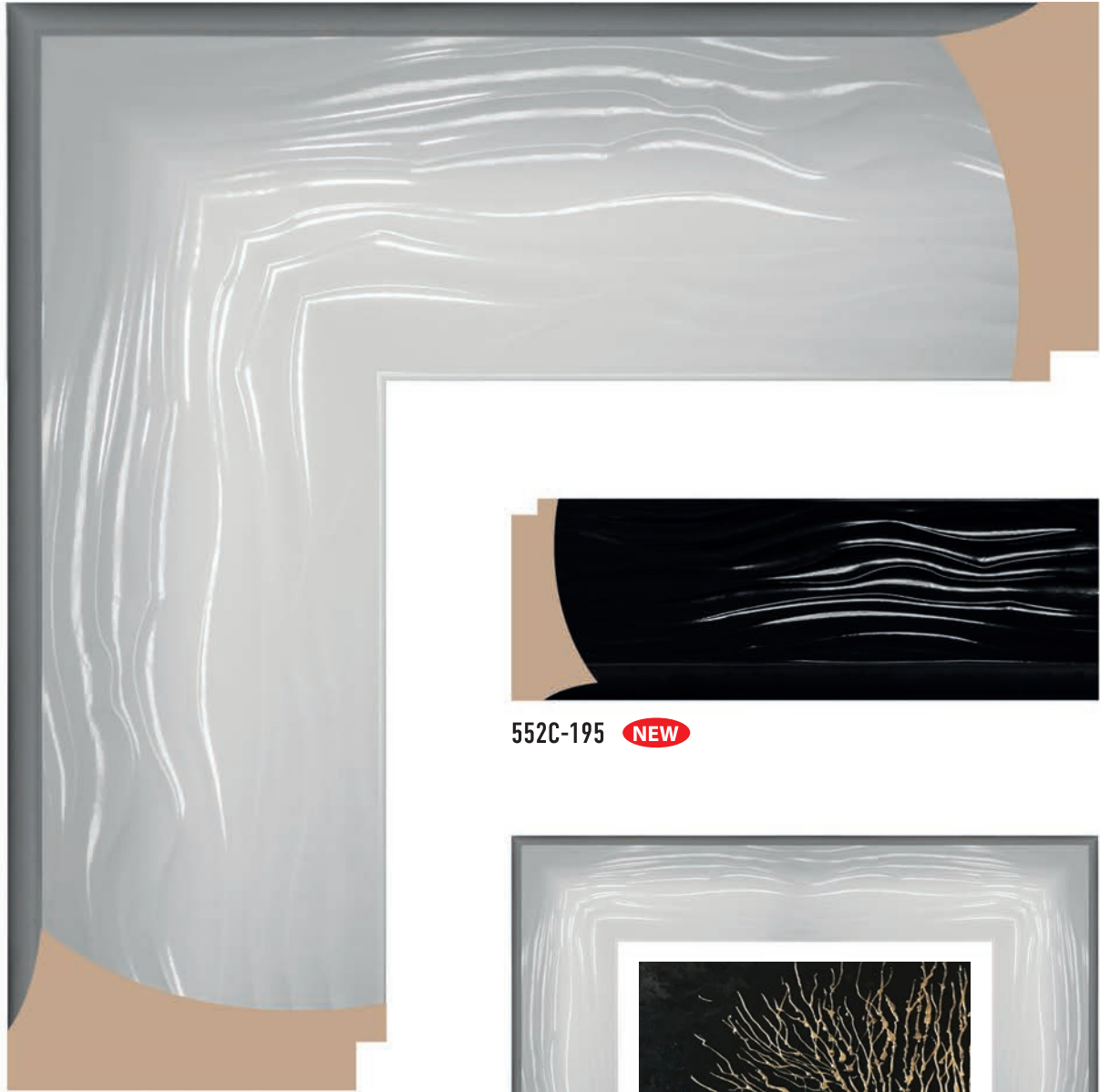

552C-114 **NEW**

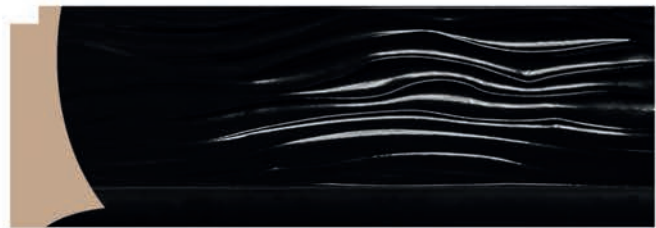

552C-195 **NEW**

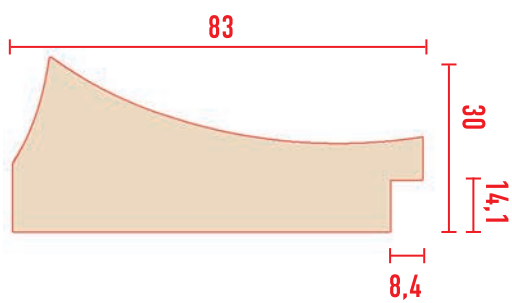



NEW 552D-114

NEW 552D-195

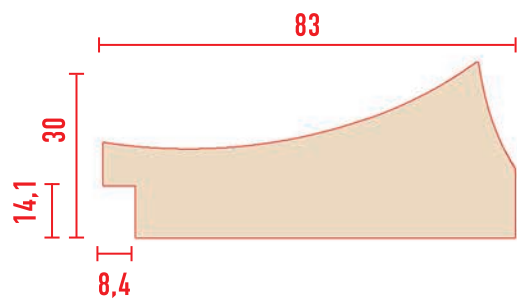



228-565



228-650

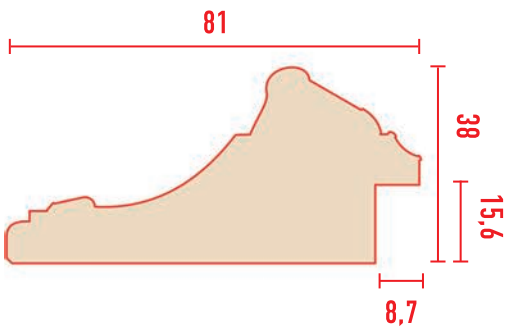



S18-966



S18-1223



S18-1224





696-182



696-401

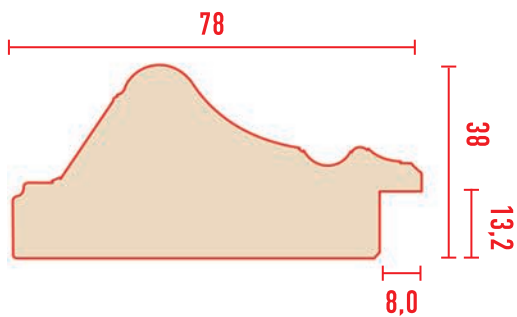

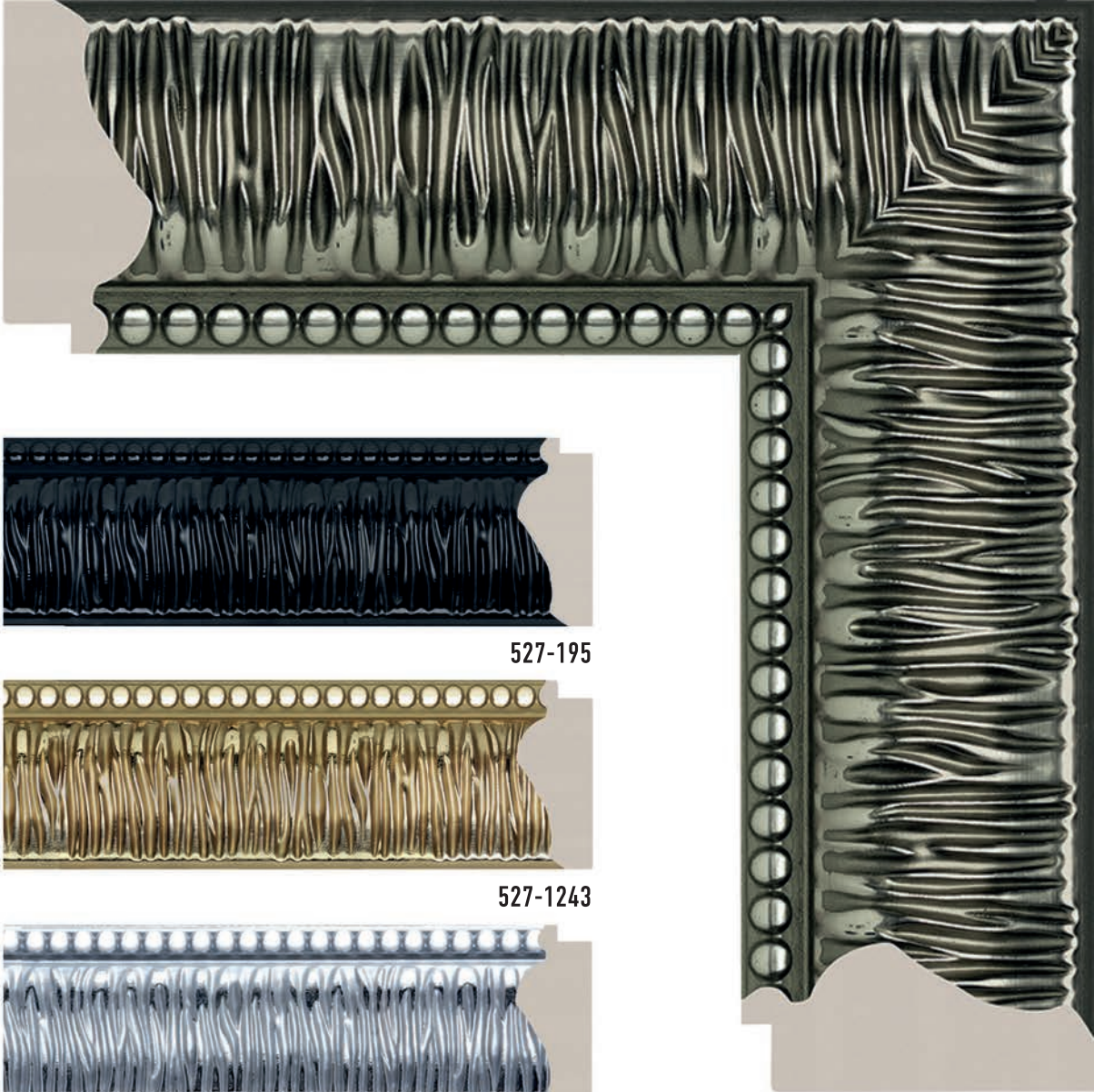

527-195

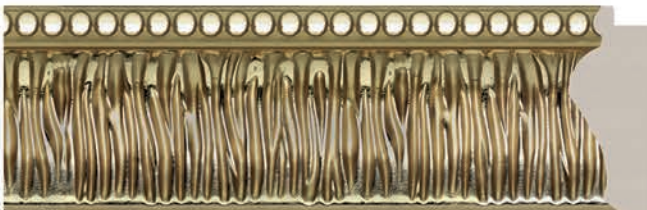

527-1243



527-1244



527-114

527-725

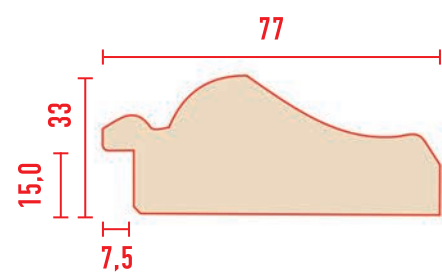



919-70 **NEW**



919-1604 **NEW**



919-1604B **NEW**



919-1605 **NEW**



919-1605B **NEW**

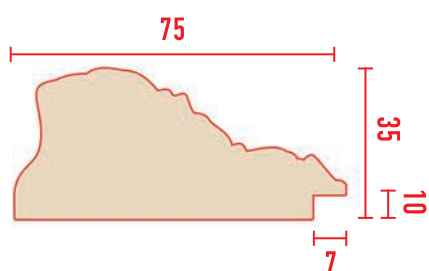



978-565



978-566

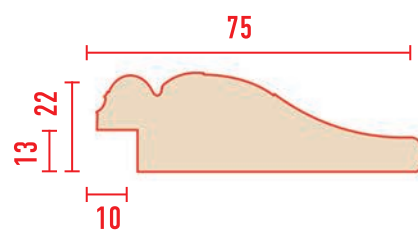



582-26



582-433



582-438



582-440



582-27

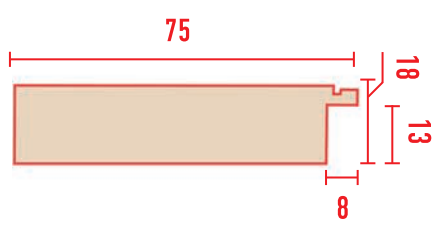

STANDARD

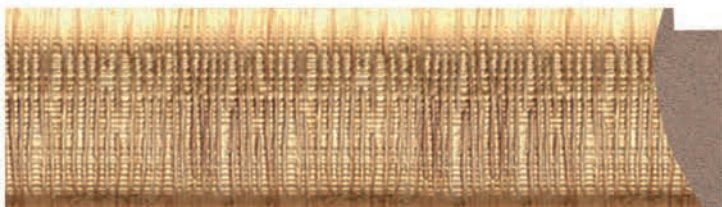

811M-905



811M-906

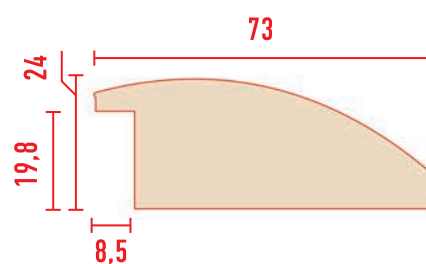



108-7



108-1333



108-1069

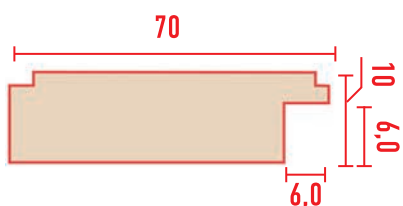

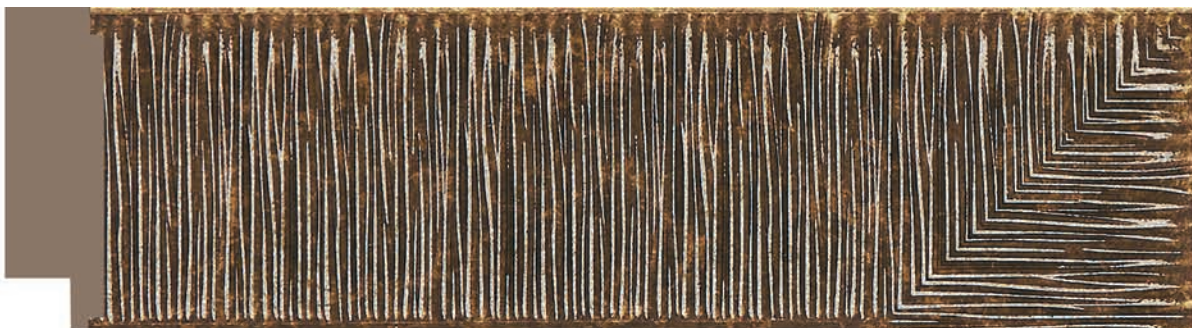

108-28

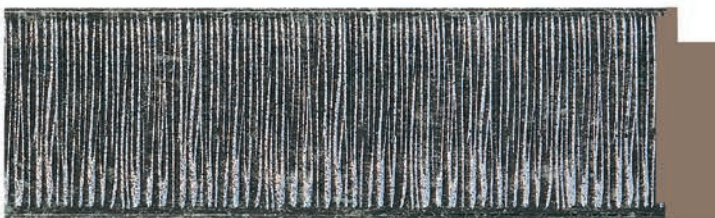

108-29



108-18



108-19



108-20



108-17

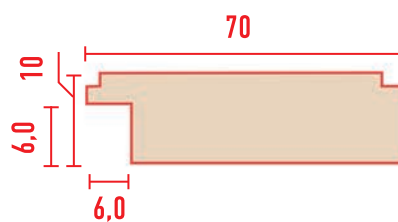



577-1223



577-966

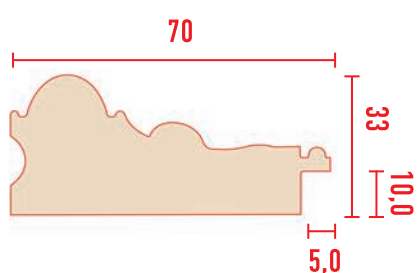
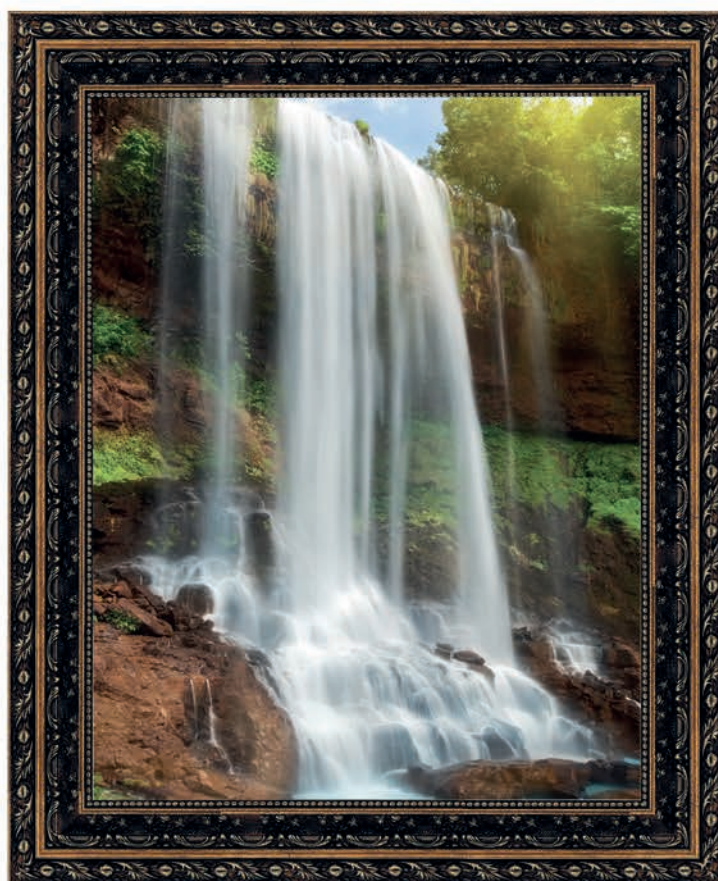



566-1224



NEW 566-1606



NEW 566-1607



NEW 566-1608



NEW 566-1609

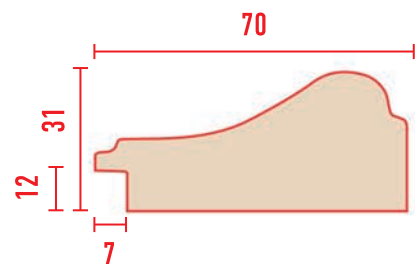



690-182



690-198

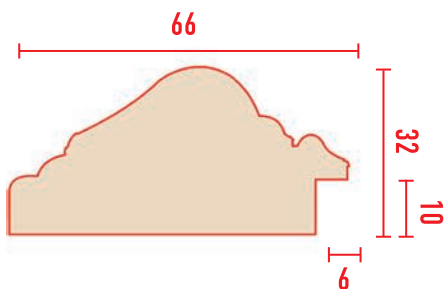



524-1333



524-1069



524-1070

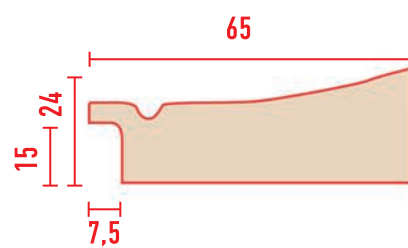



176-2



176-1



176-3



176-4



176-5



176-6

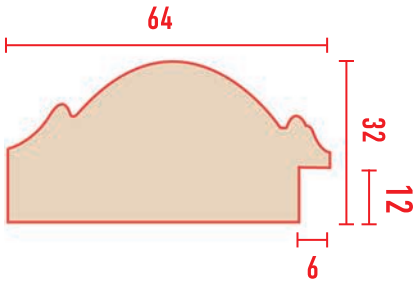



829-294



829-935



829-934

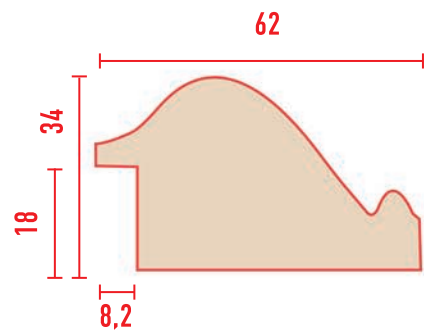



304 -127



304 -566



304 -126

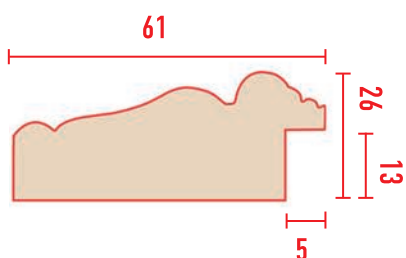



808-553



808-176N



808-552



808-176S

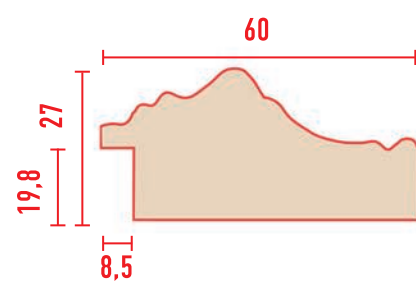



коллекция

РЕНЕССАНС



587-70 **NEW**



587-1604 **NEW**



587-1604B **NEW**



587-1605 **NEW**



587-1605B **NEW**

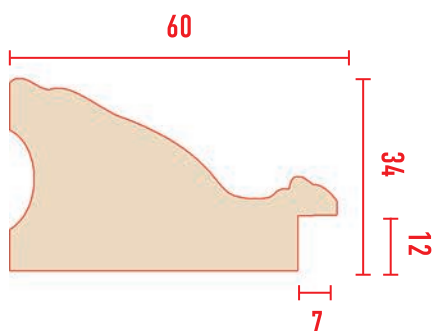

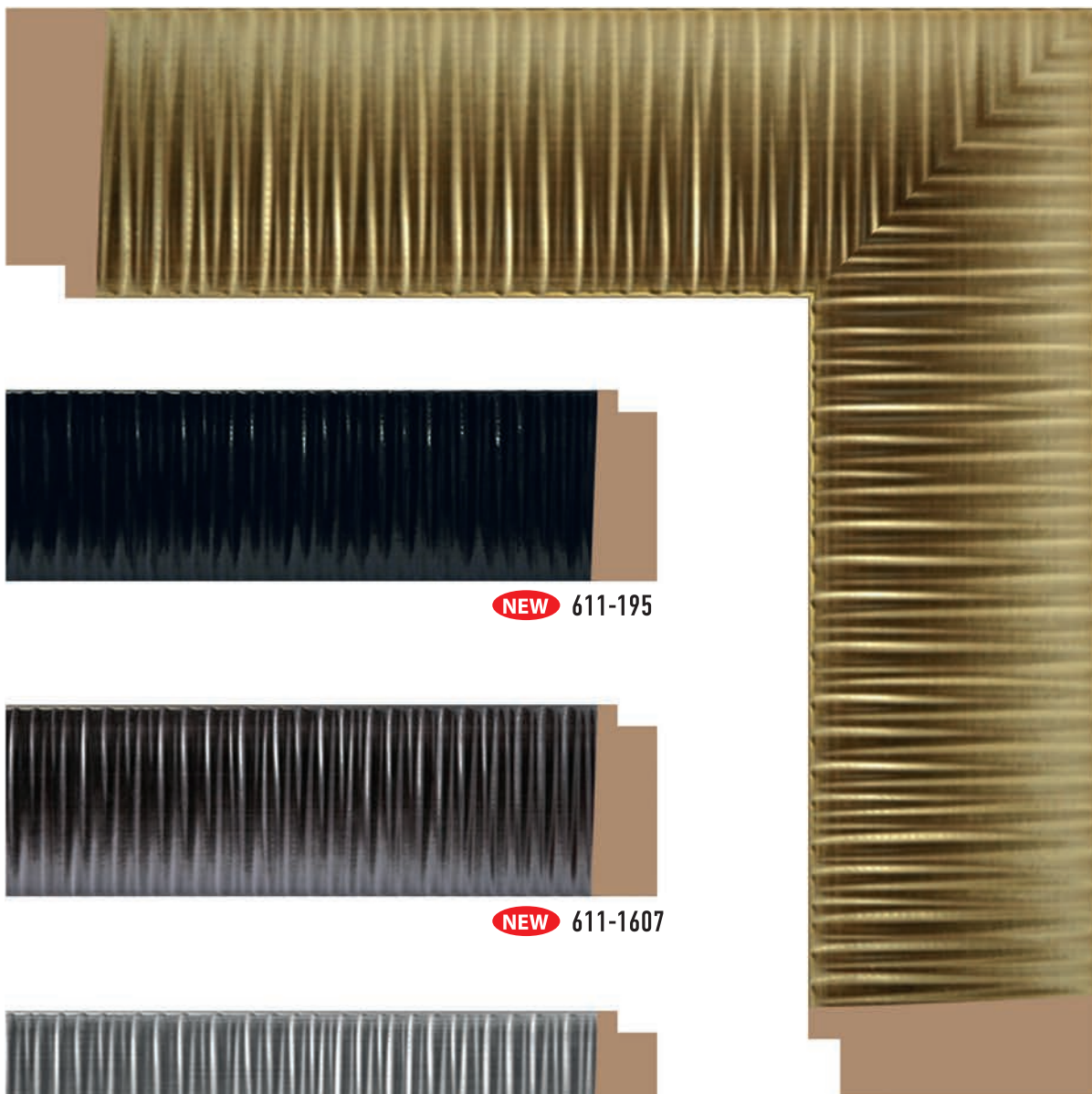

NEW 611-195



NEW 611-1607



NEW 611-1610

NEW 611-1608

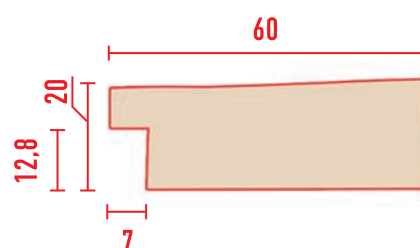



175-3



175-1



175-2



175-4



175-5



175-6

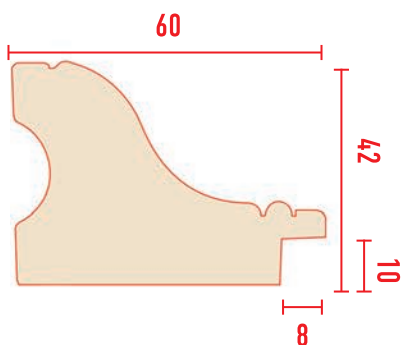



548M-440

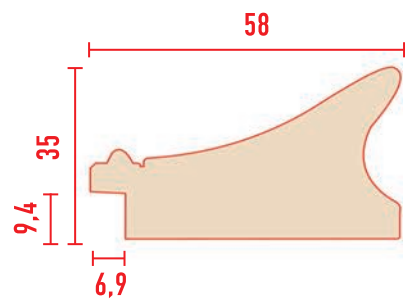

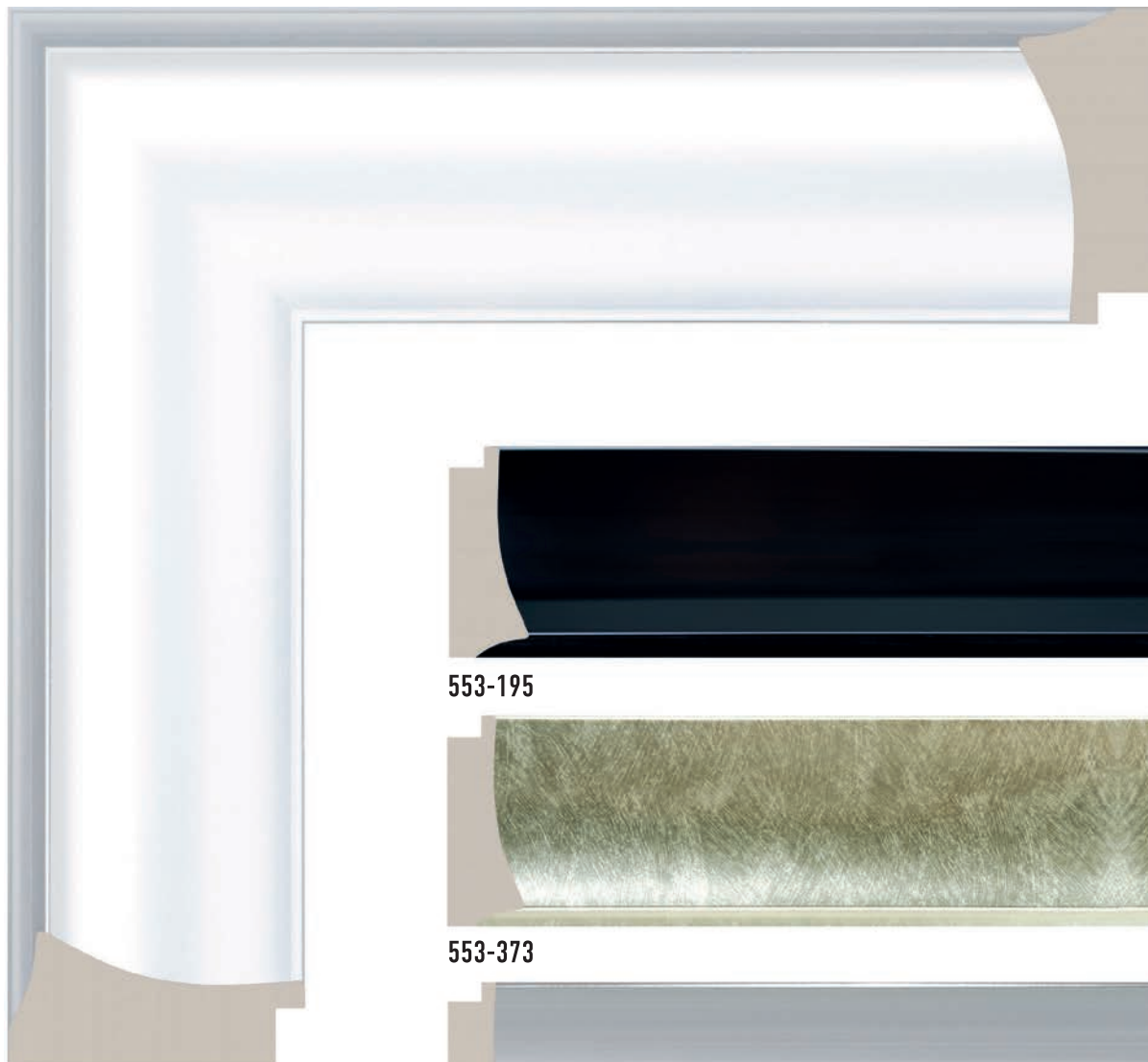

553-114

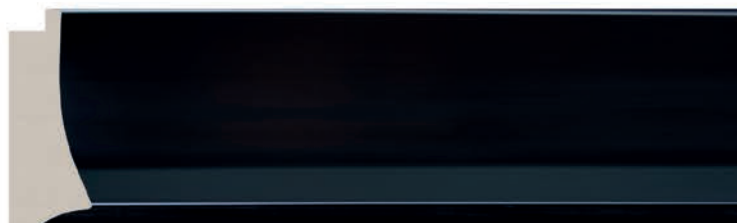

553-195



553-373



553-1153

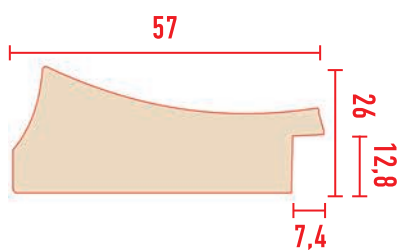



556-2



556-4



556-6

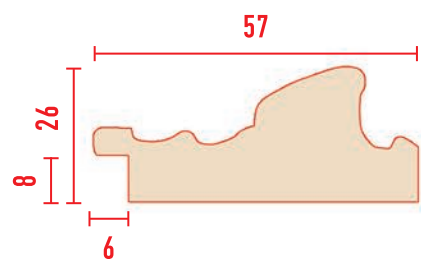

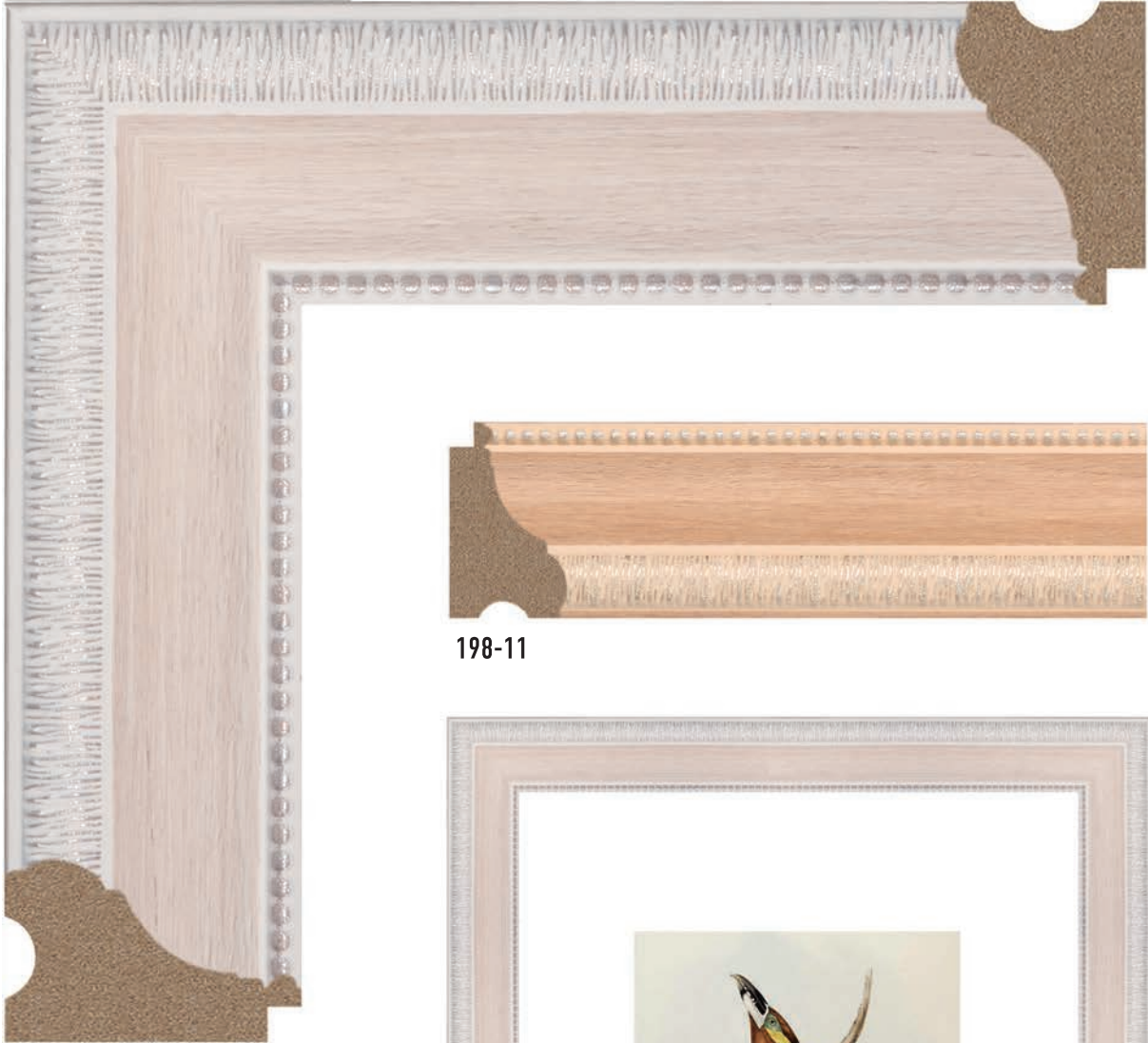

198-14

198-11

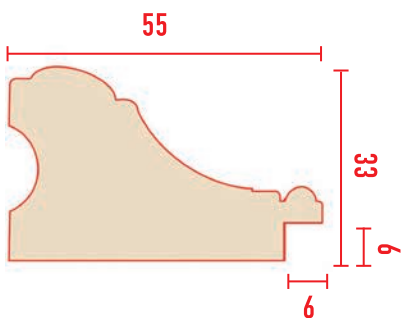



J11-966



J11-1223



J11-115



J11-1224

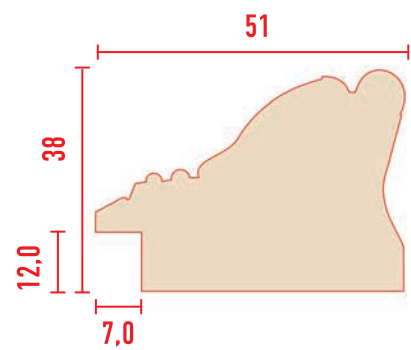

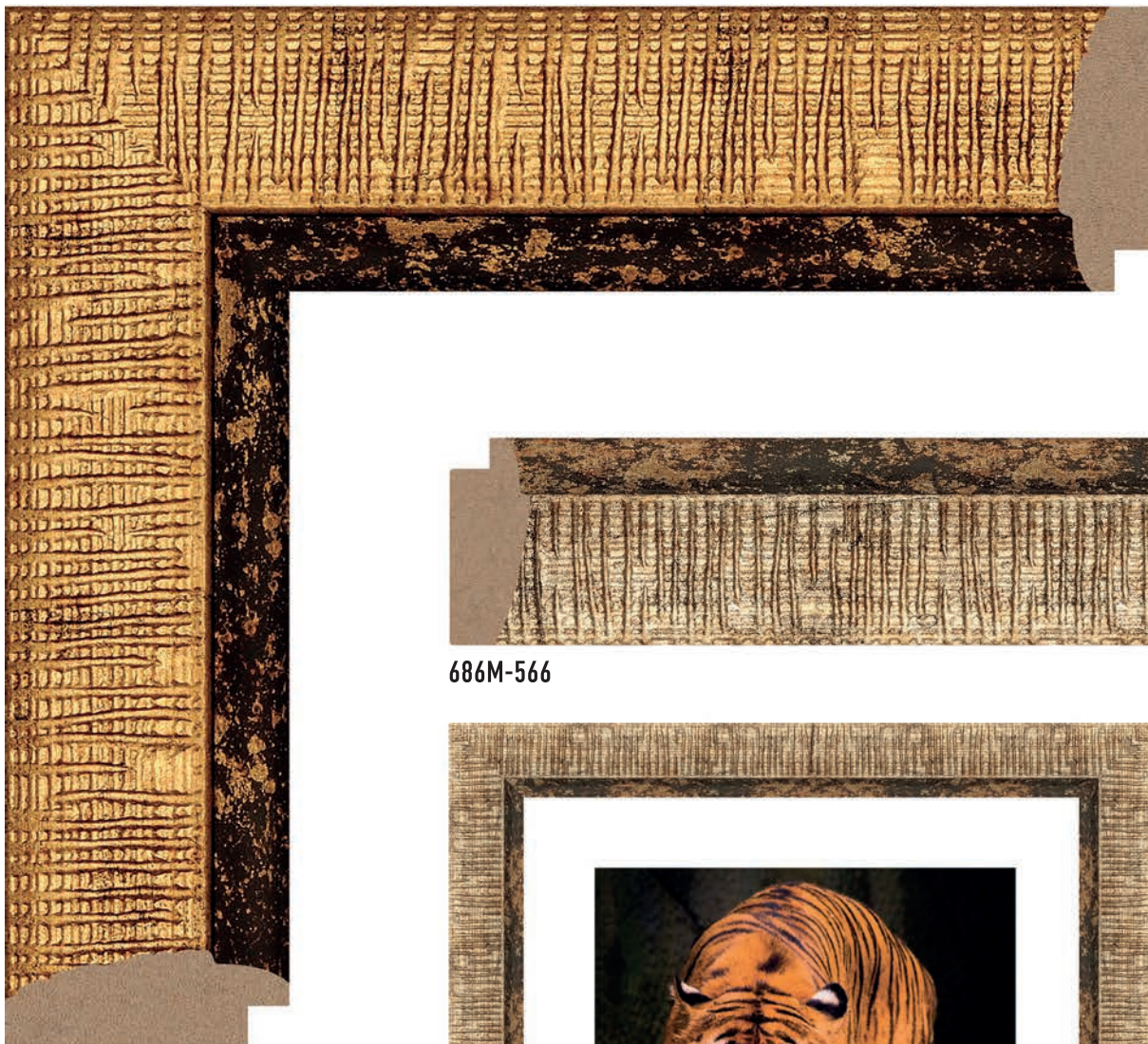

686M-565



686M-566

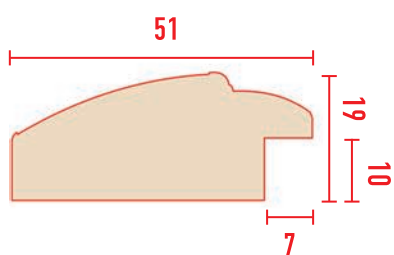

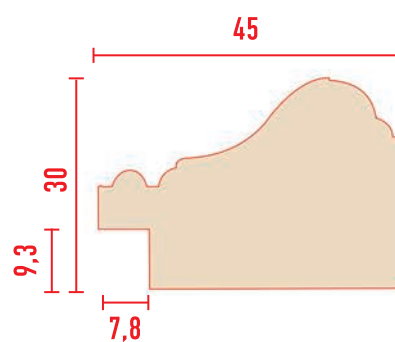
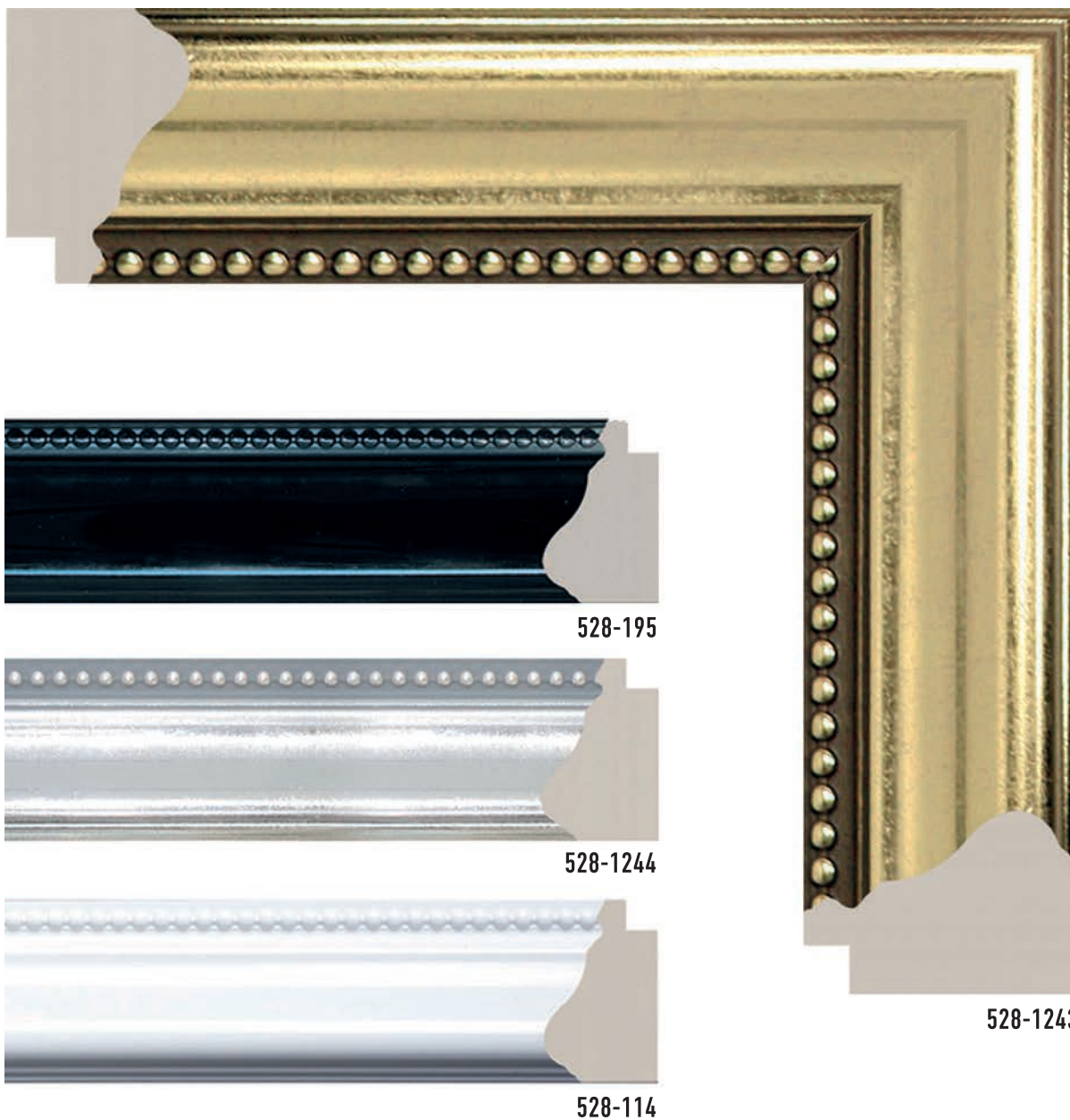



J13-966



J13-1223



J13-1224

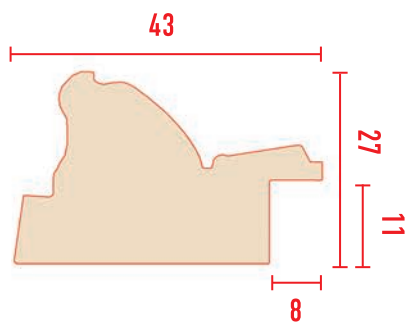

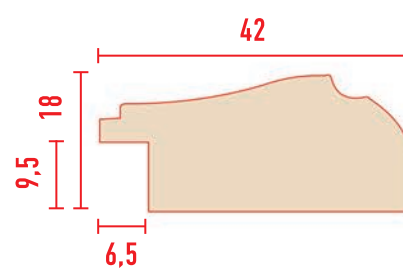
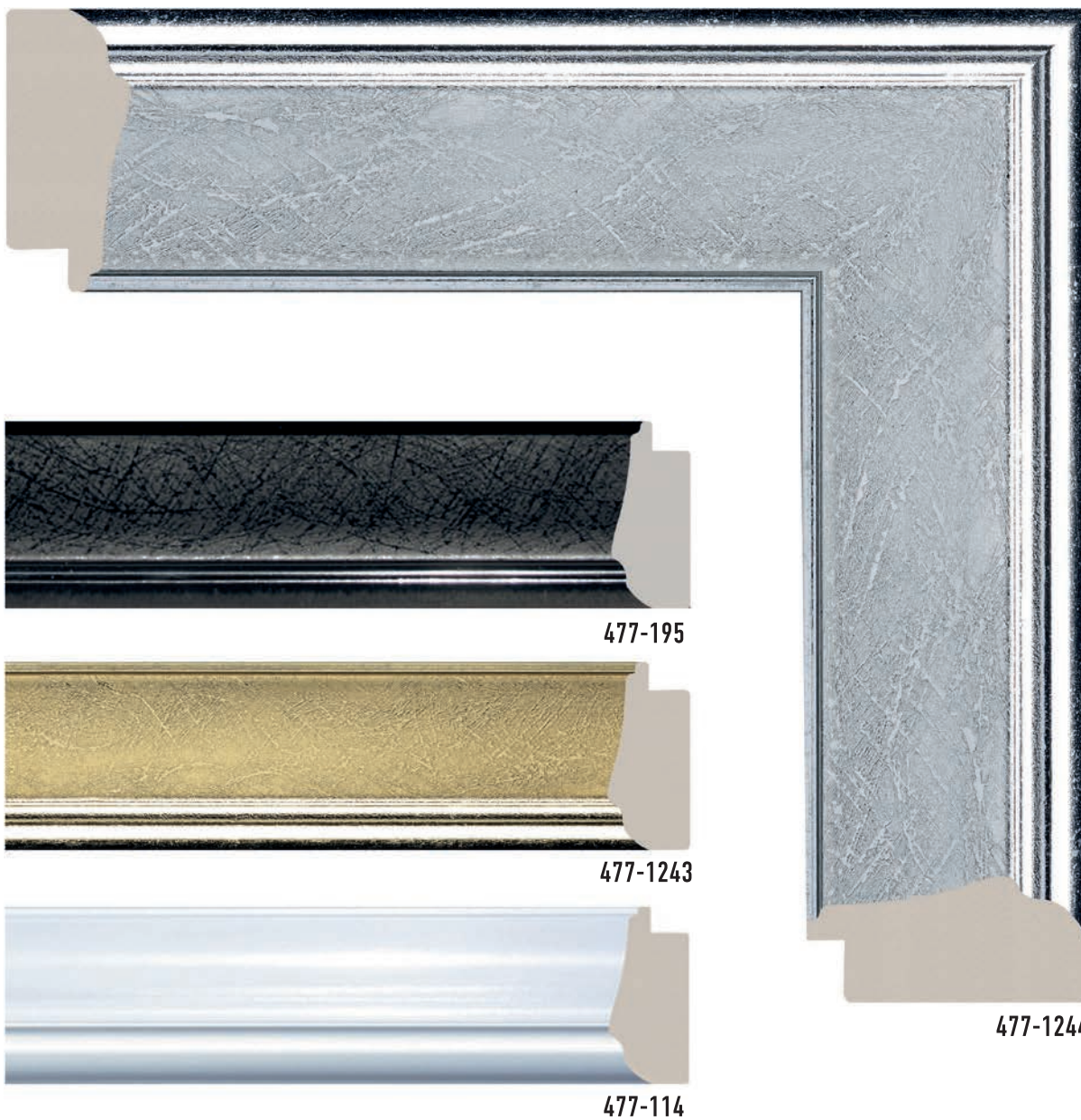



807-2

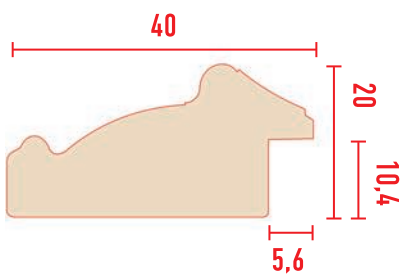

807-1



807-3



807-4



807-5



807-6



807-7D

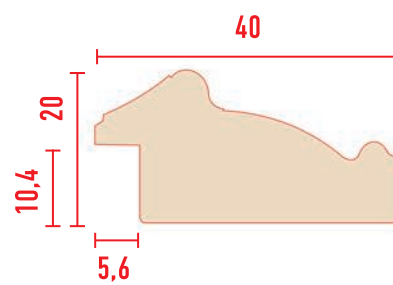



807-552



807-553



807-43



807-44



807-41



807-40



807-42

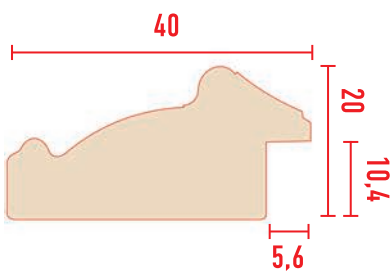

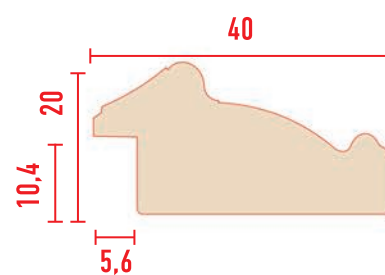



109-15

109-11

109-13

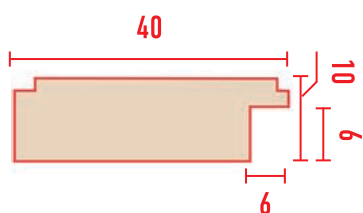



109-17

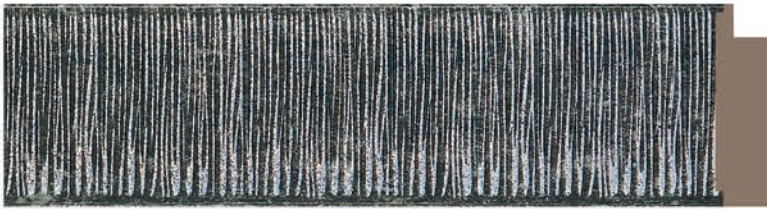

109-29



109-18



109-19



109-20



109-28

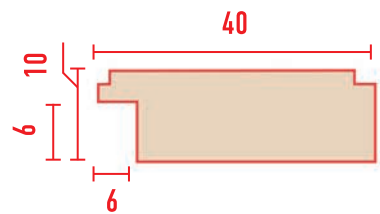



685-217



685-221



685-126



685-127



685-182

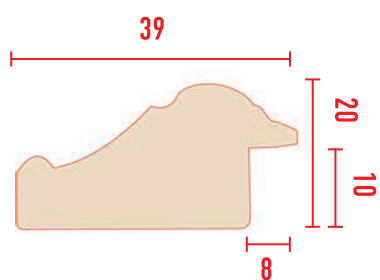



J12-966



J12-1223



J12-1224

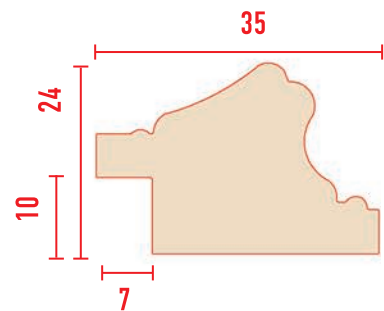



534-15

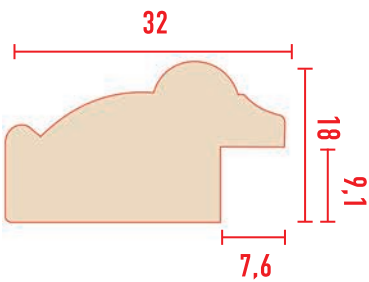

534-51



534-52



534-53



534-11



534-13



534-14



651-176s



651-176

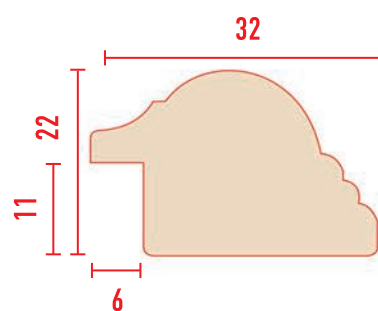



564-278



564-277



564-280

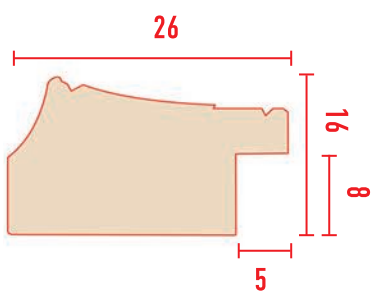



584-1070



584-1069

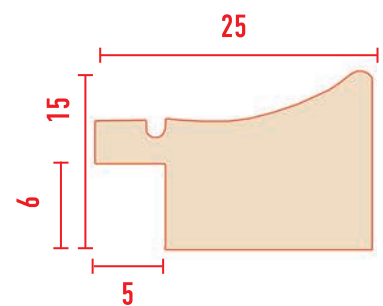

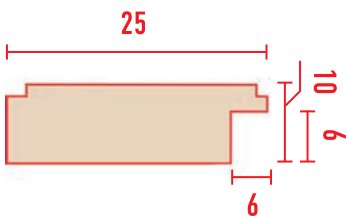

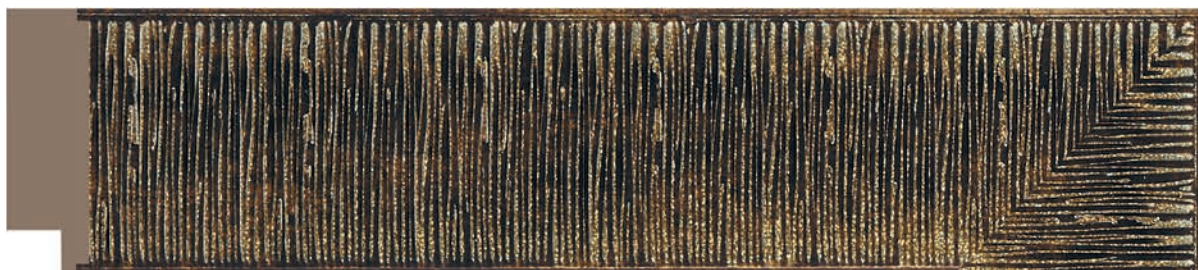

102-51



102-52



102-17



102-53



102-29



102-28

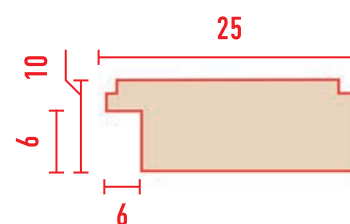

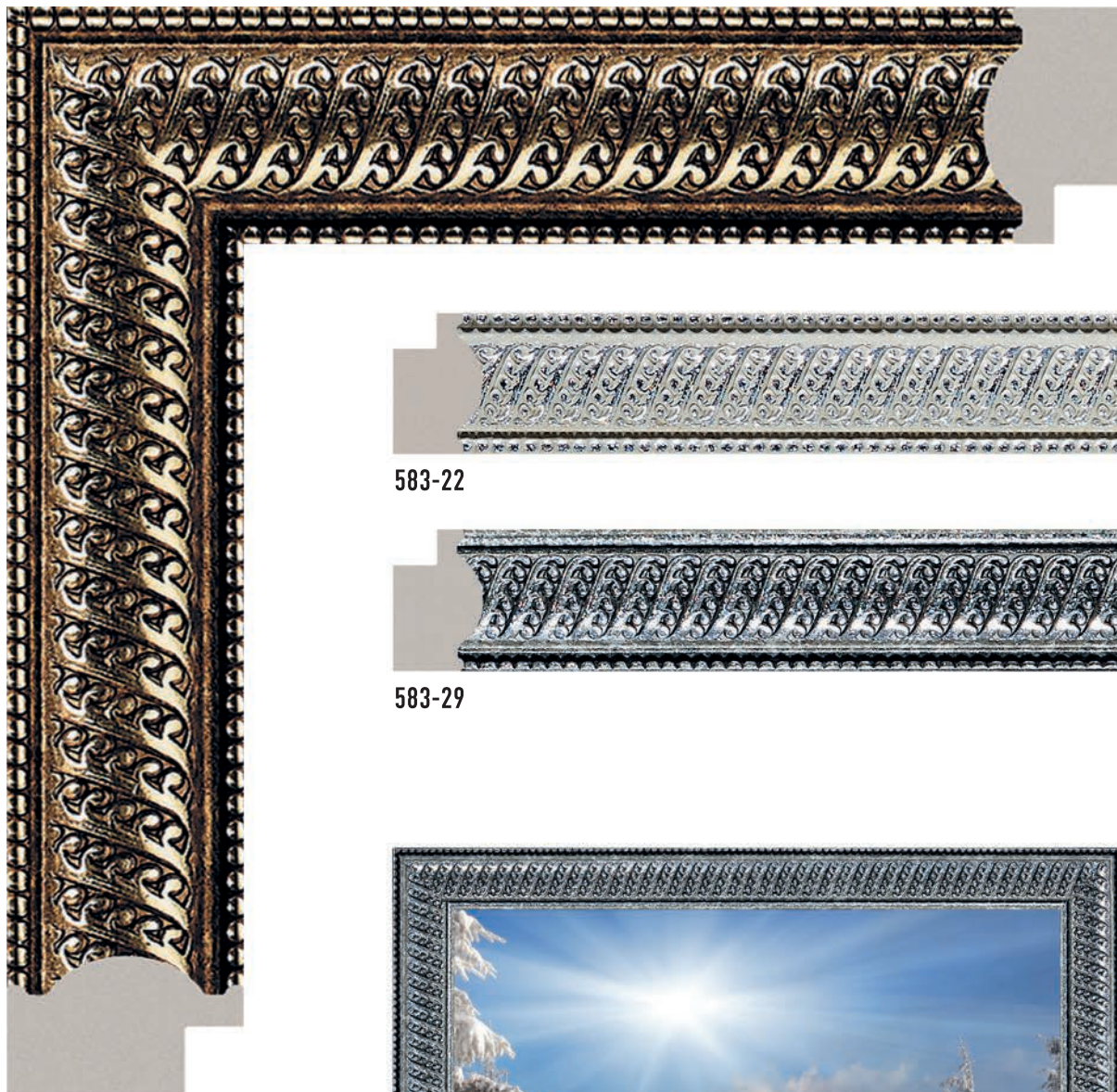

583-28



583-22



583-29

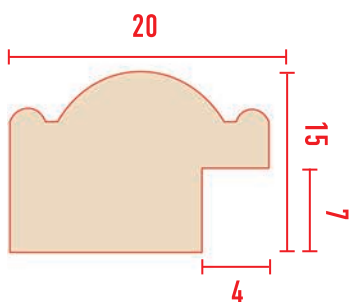



158-1



158-3



158-4



158-5



158-6



158-7D



158-937



158-933



158-55

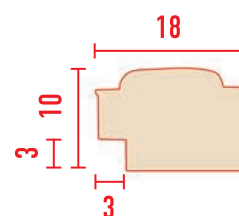



158-552

158-767

158-1084

158-553

158-54

158-115

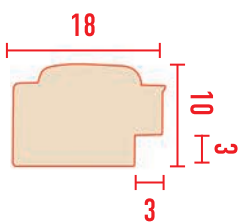



158-281



158-118



158-127



158-126



158-1028

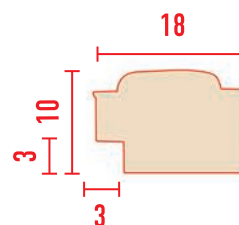

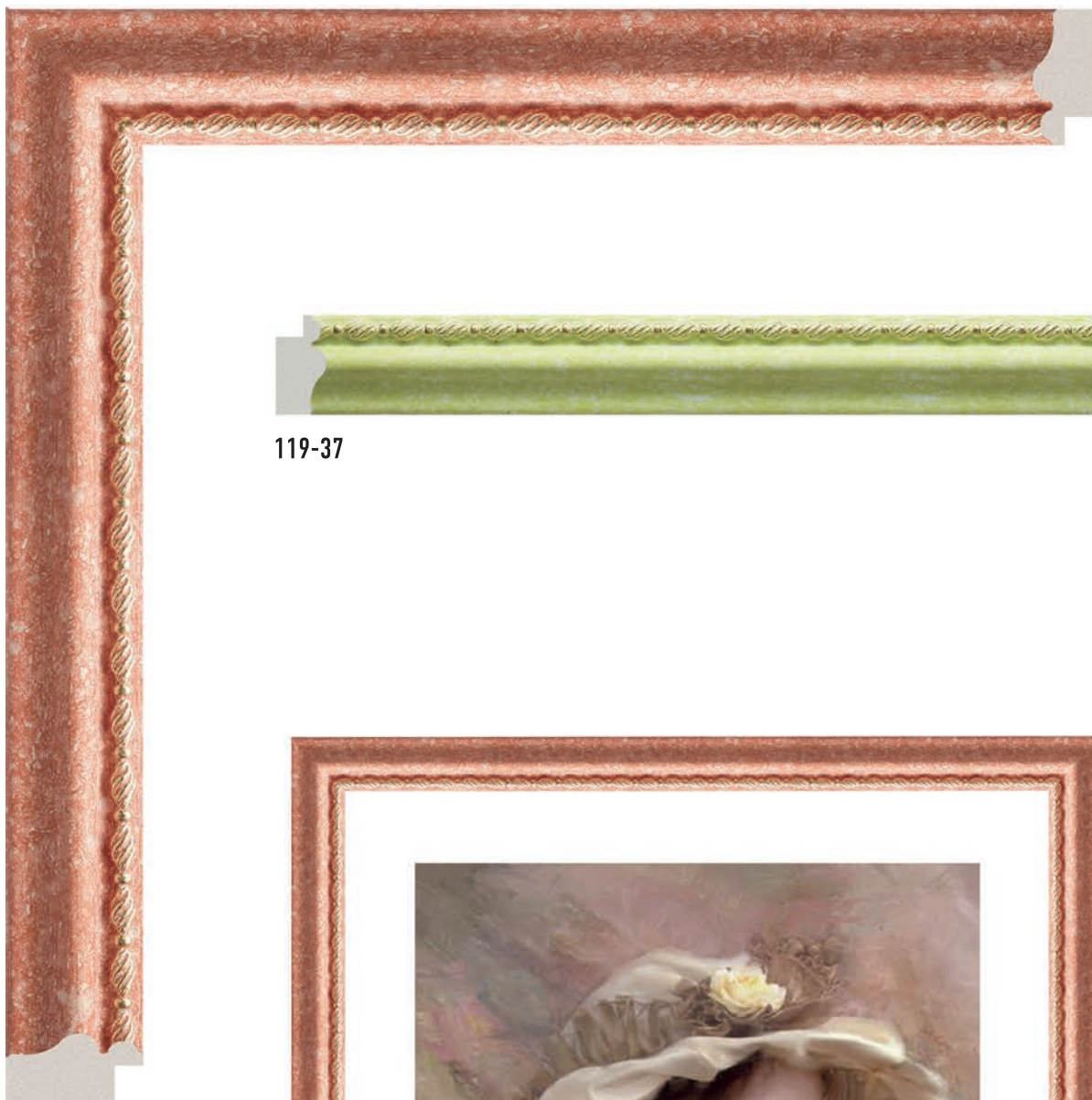

119-37

119-34

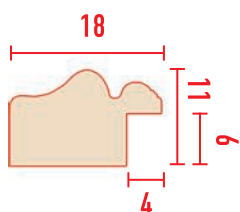



149-956



149-954

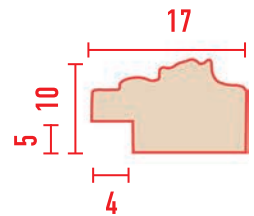

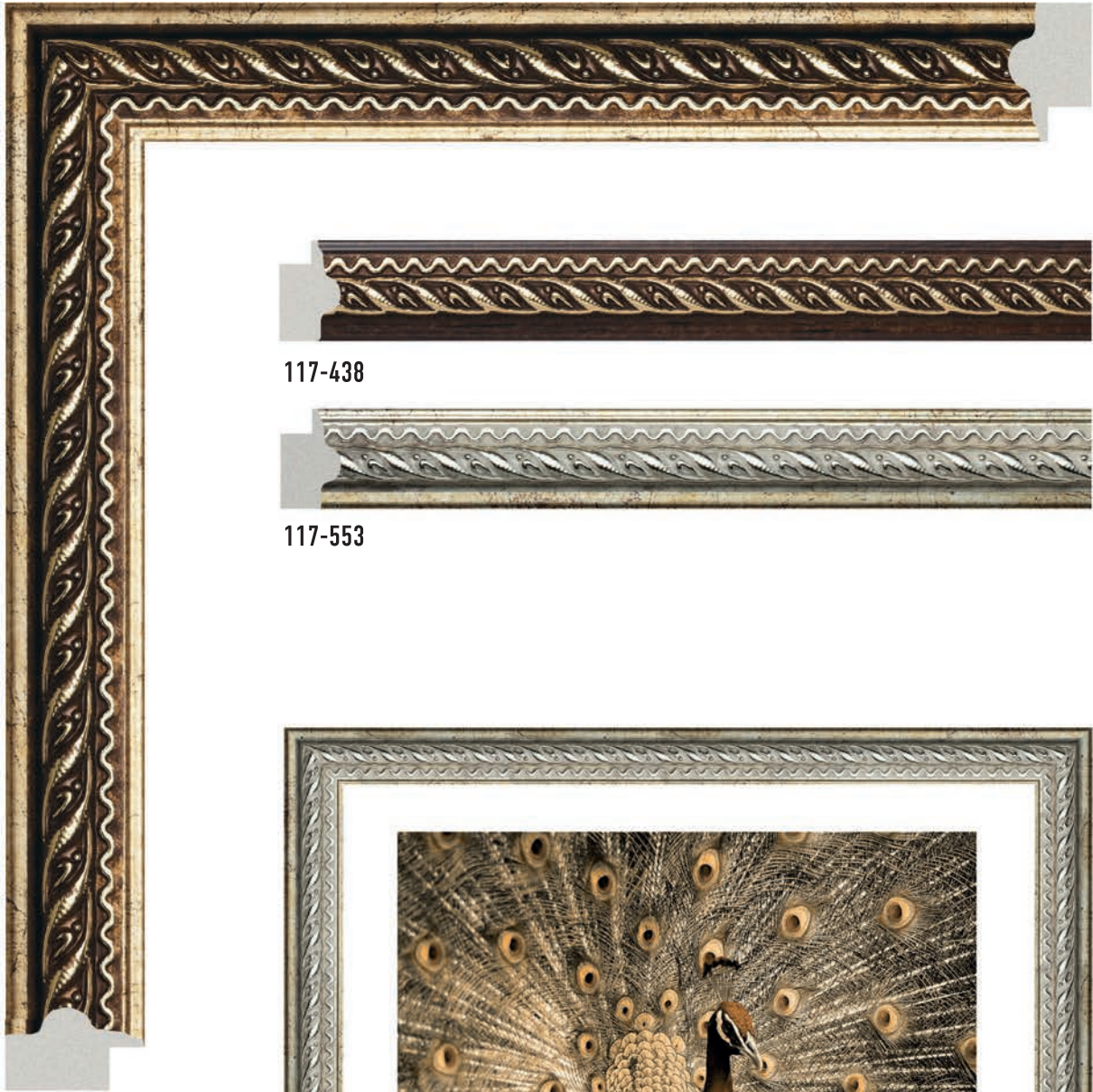

117-552

117-438

117-553

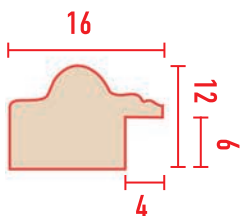



159B-565

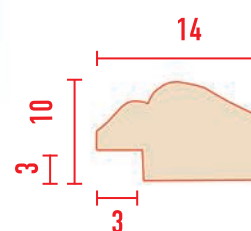



159D-553

159D-552

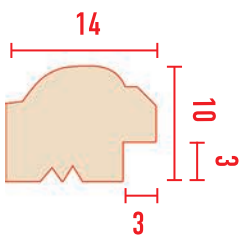

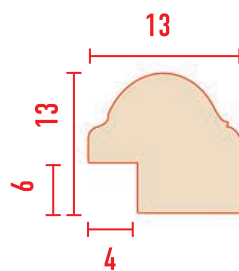



коллекция

ЭКЛЕКТИКА



FM22-2



FM22-1



FM22-3



FM22-4

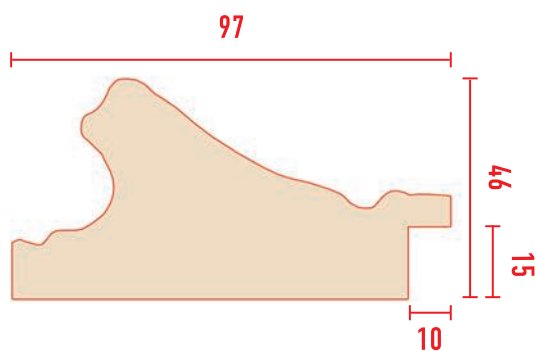



FM9-1



FM9-3



FM9-4



FM9-5

FM9-2

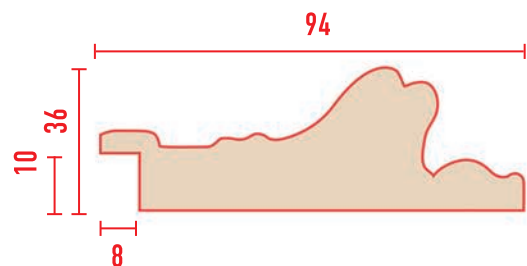



FM28-2

FM28-1

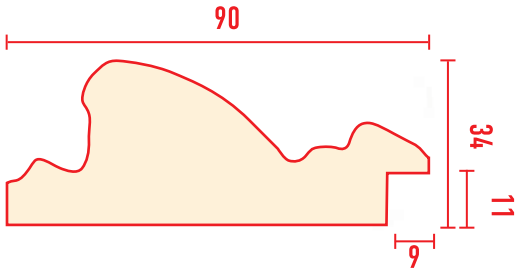



FM26-2

FM26-1

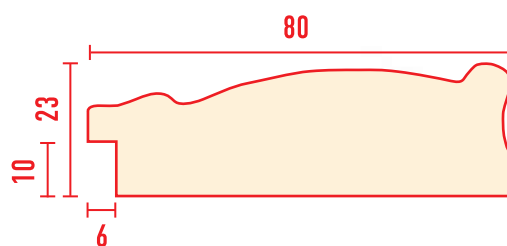



FM8-2



FM8-1

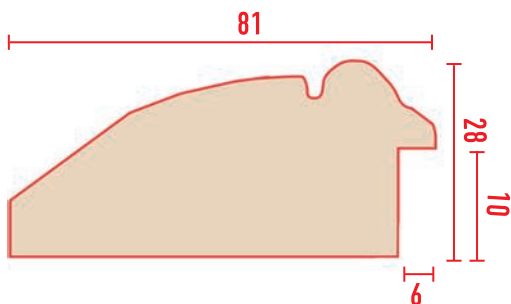

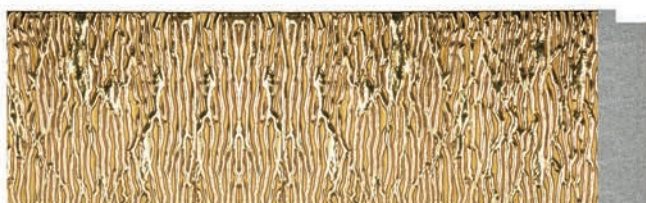

FM4-3

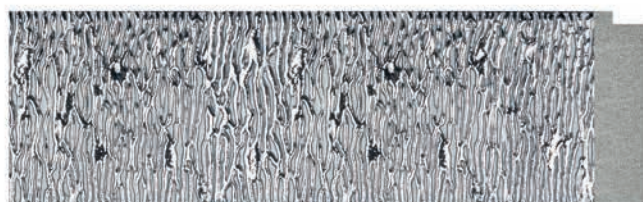

FM4-1



FM4-4



FM4-2

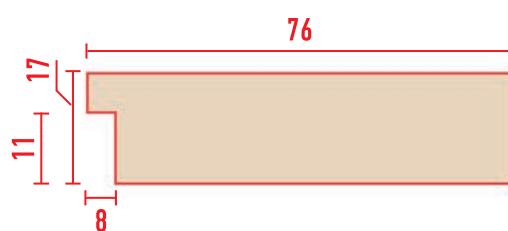

коллекция



ЭКЛЕКТИКА



FM29-2

FM29-1

FM29-3

FM29-4

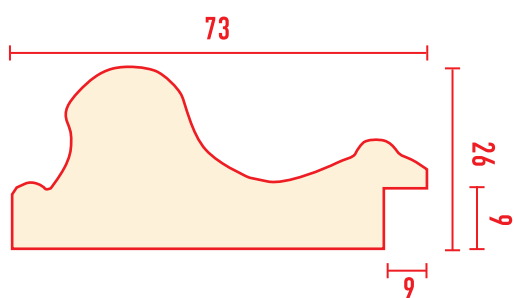

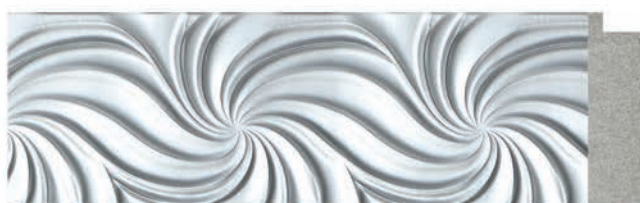

FM25-1



FM25-2



FM25-3



FM25-4

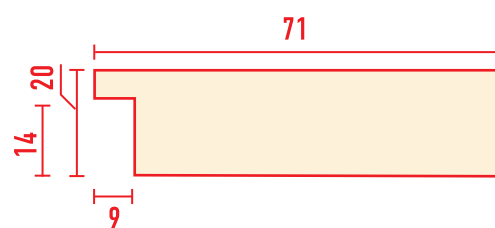



коллекция

ЭКЛЕКТИКА



FM24-1

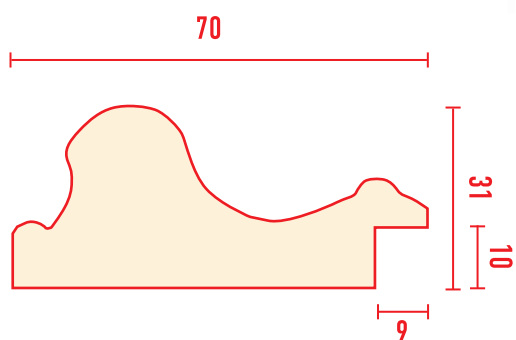



FM11-2

FM11-1

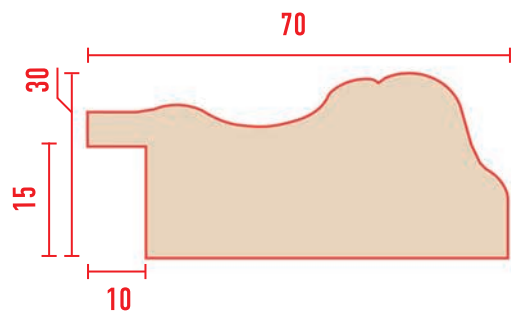



FM14-1

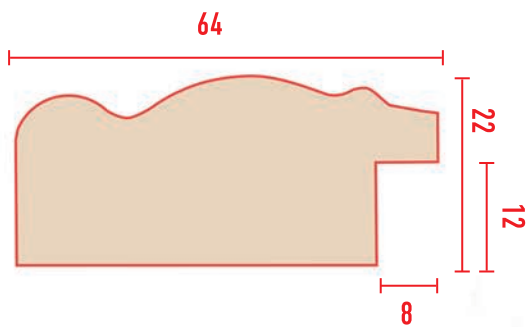

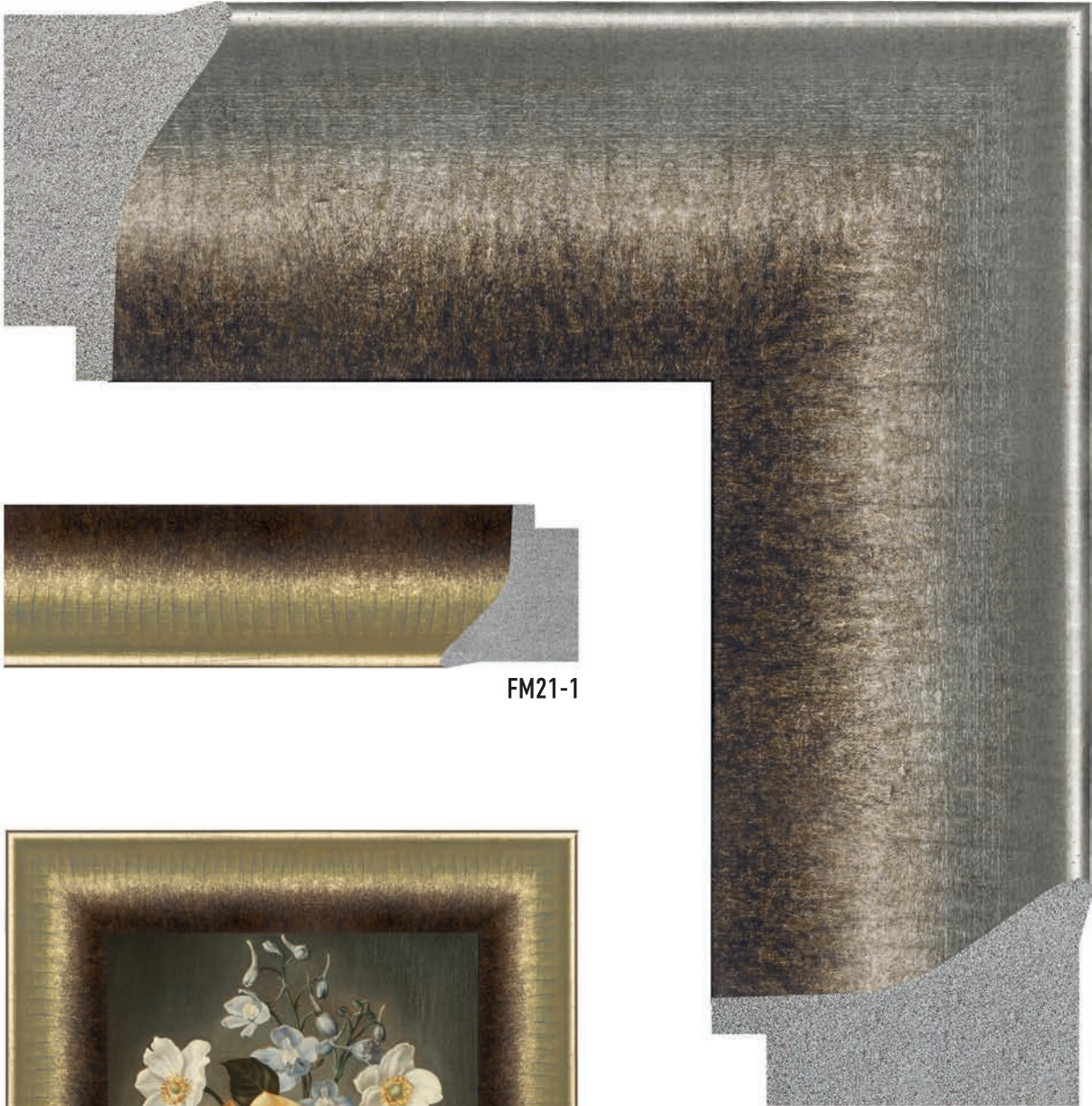

FM21-1



FM21-2

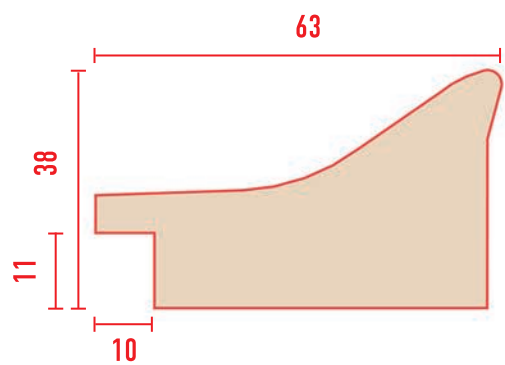



коллекция

ЭКЛЕКТИКА



FM10-3

FM10-2

FM10-1

FM10-4

FM10-5

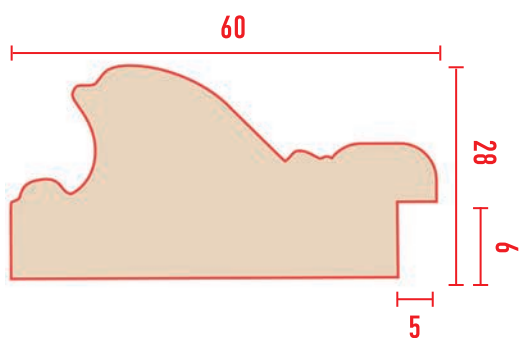



FM31-1

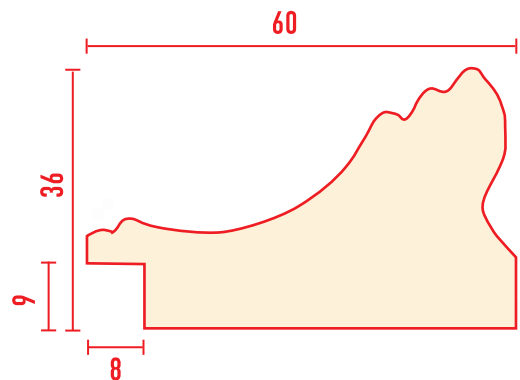



коллекция

ЭКЛЕКТИКА



FM19-1



FM19-2

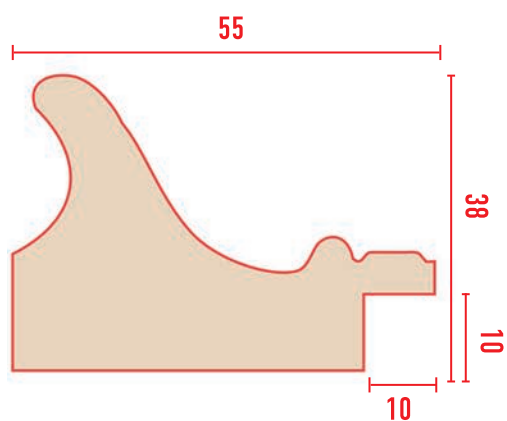



FM27-1

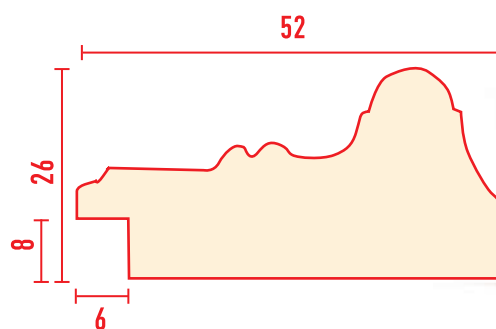



коллекция

ЭКЛЕКТИКА

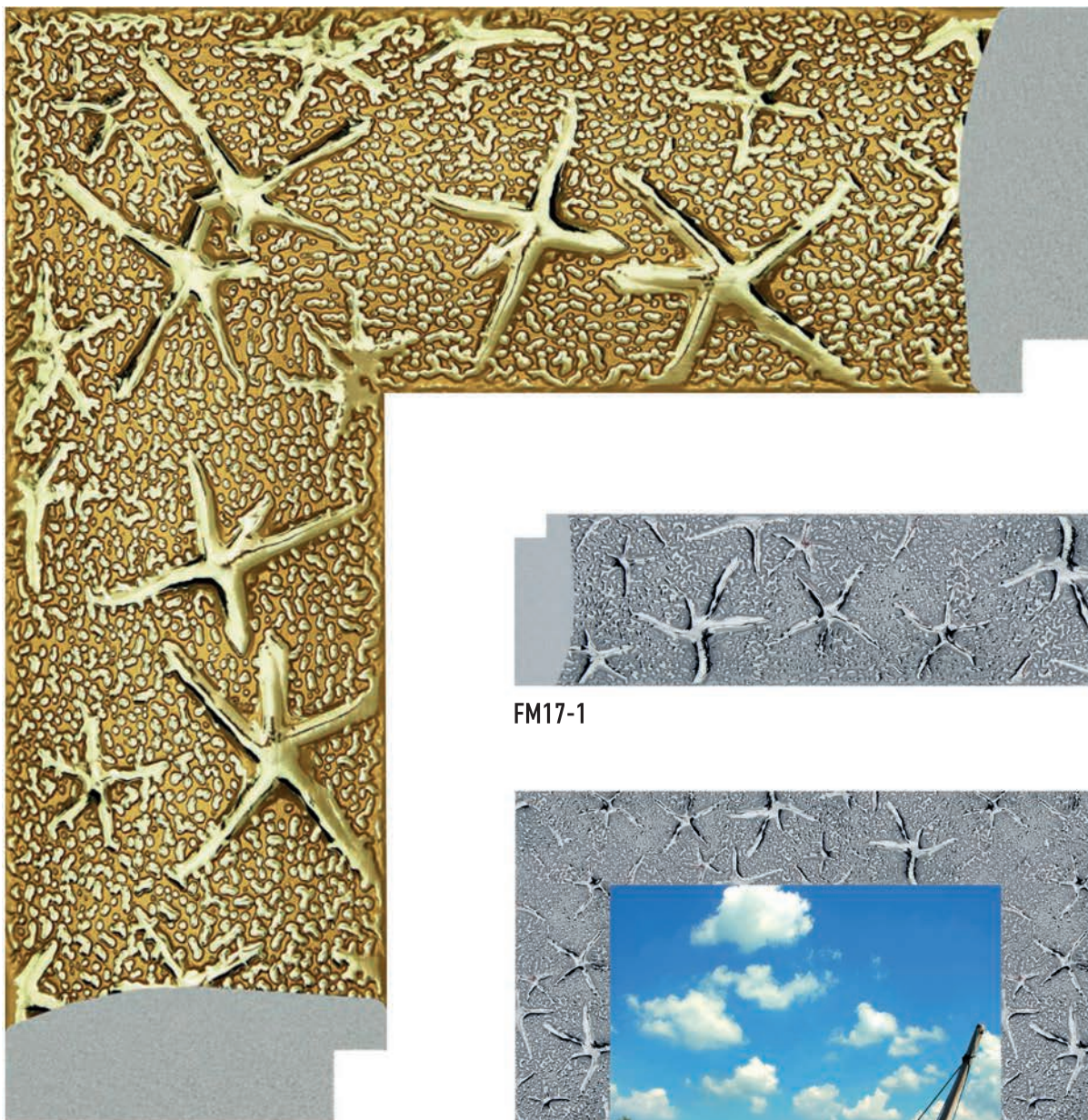

FM17-2

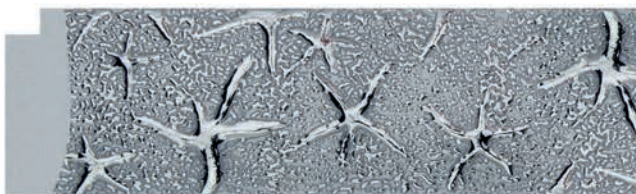

FM17-1

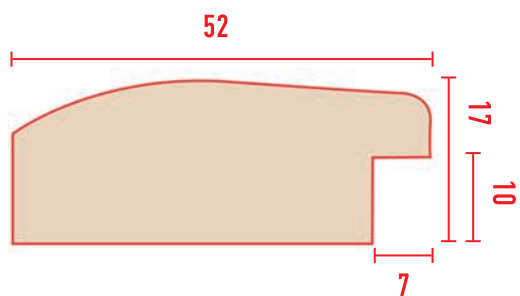



FM15-2

FM15-1

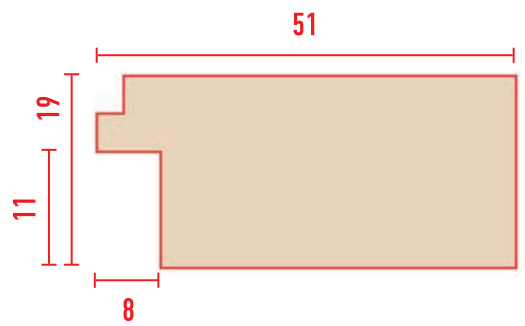



FM30-2



FM30-1



FM30-3



FM30-4

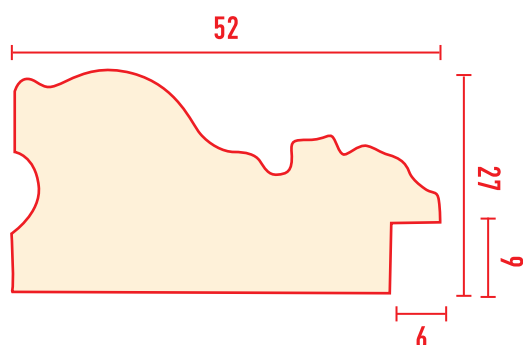



FM23-1

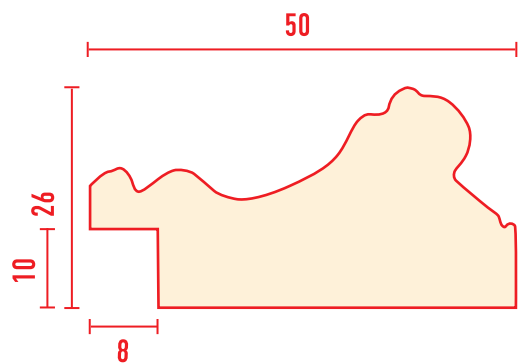

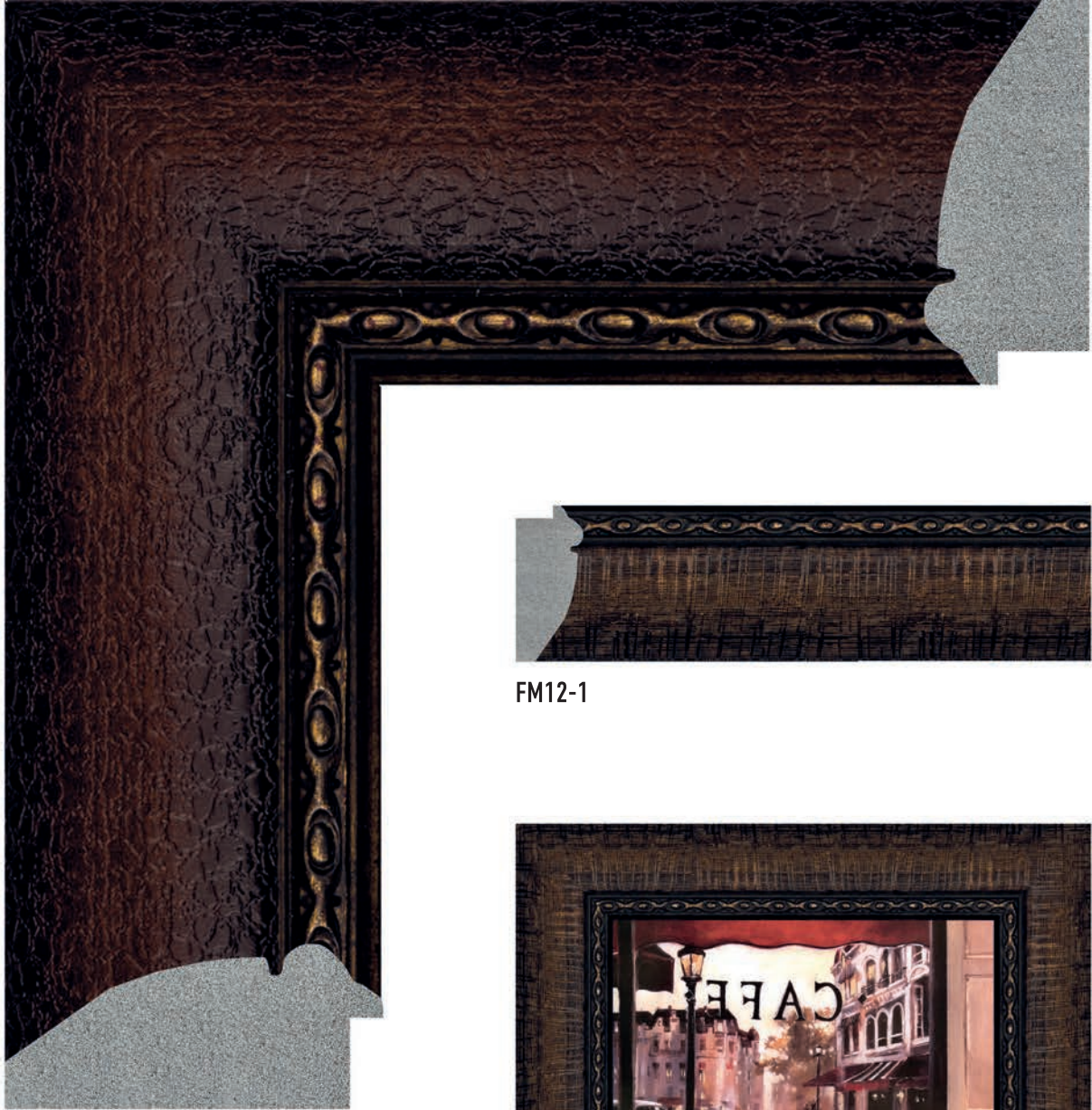

FM12-2



FM12-1

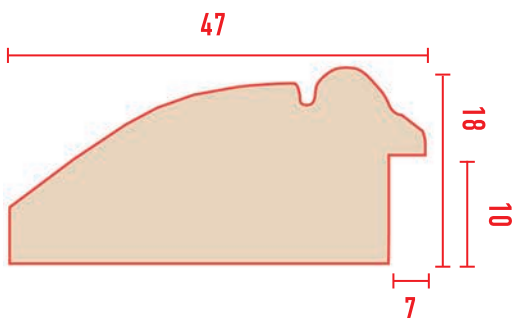



FM18-2

FM18-4

FM18-1

FM18-3

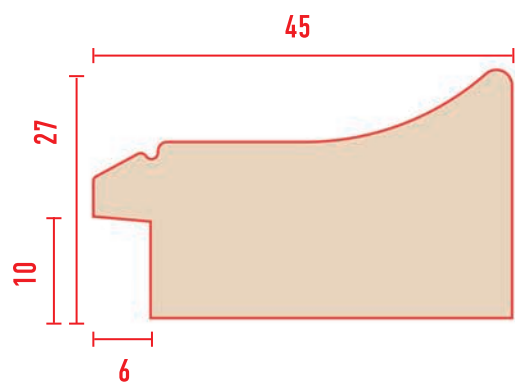



коллекция

ЭКЛЕКТИКА

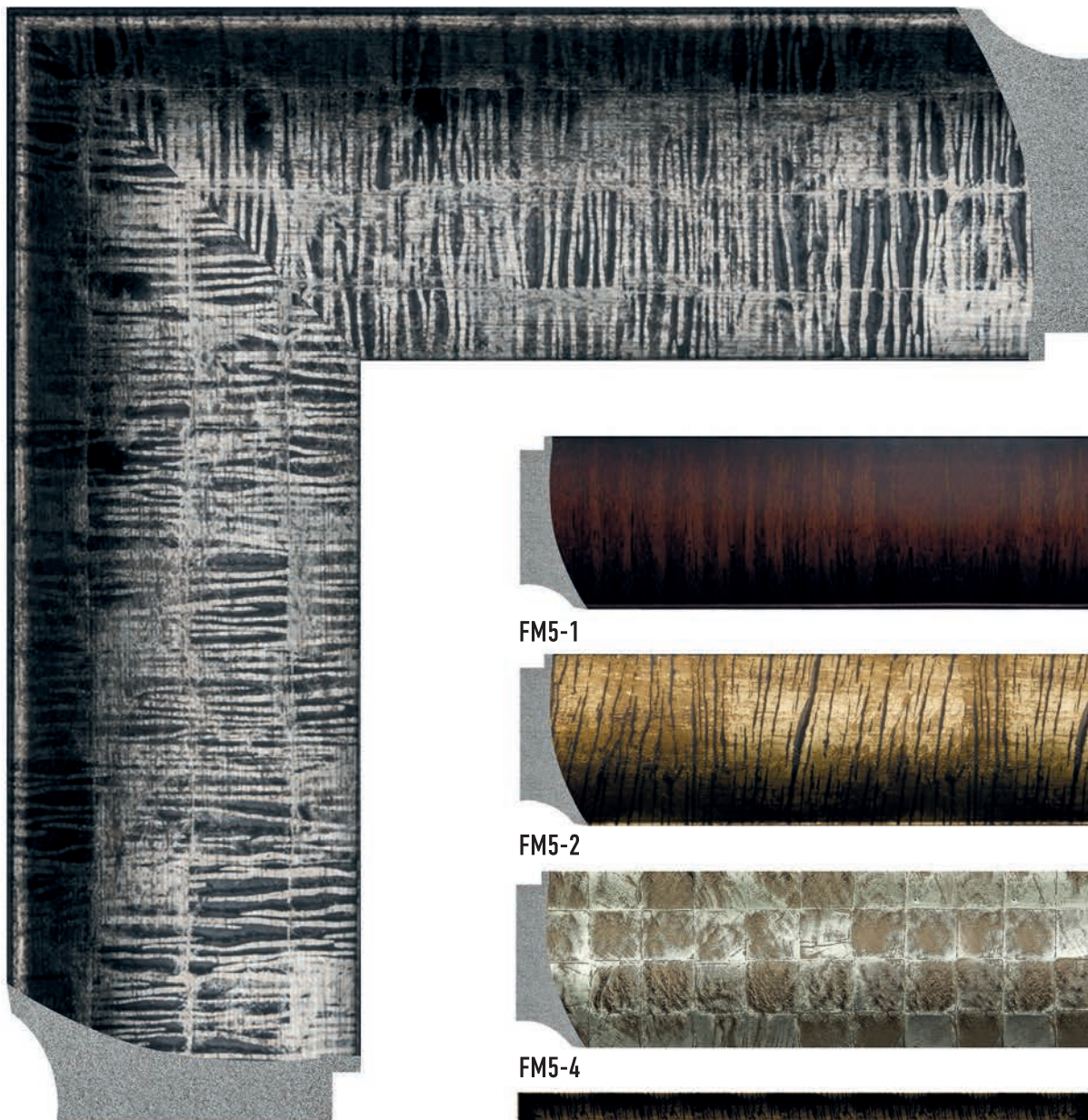

FM5-3



FM5-1



FM5-2



FM5-4

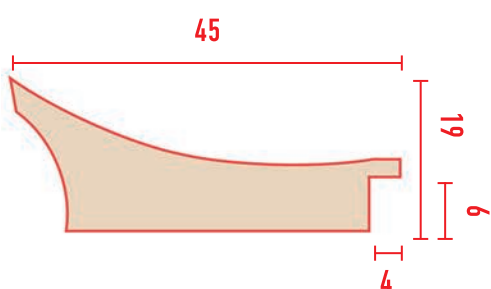



FM6-2

FM6-1

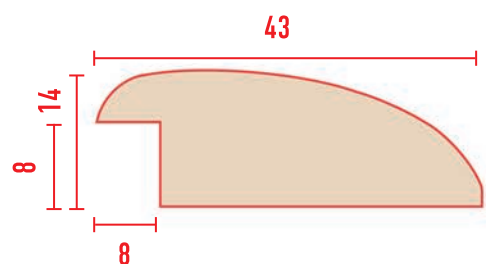



FM20-1

FM20-2

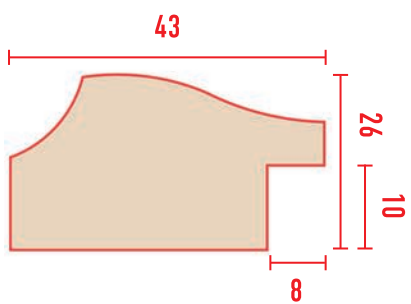

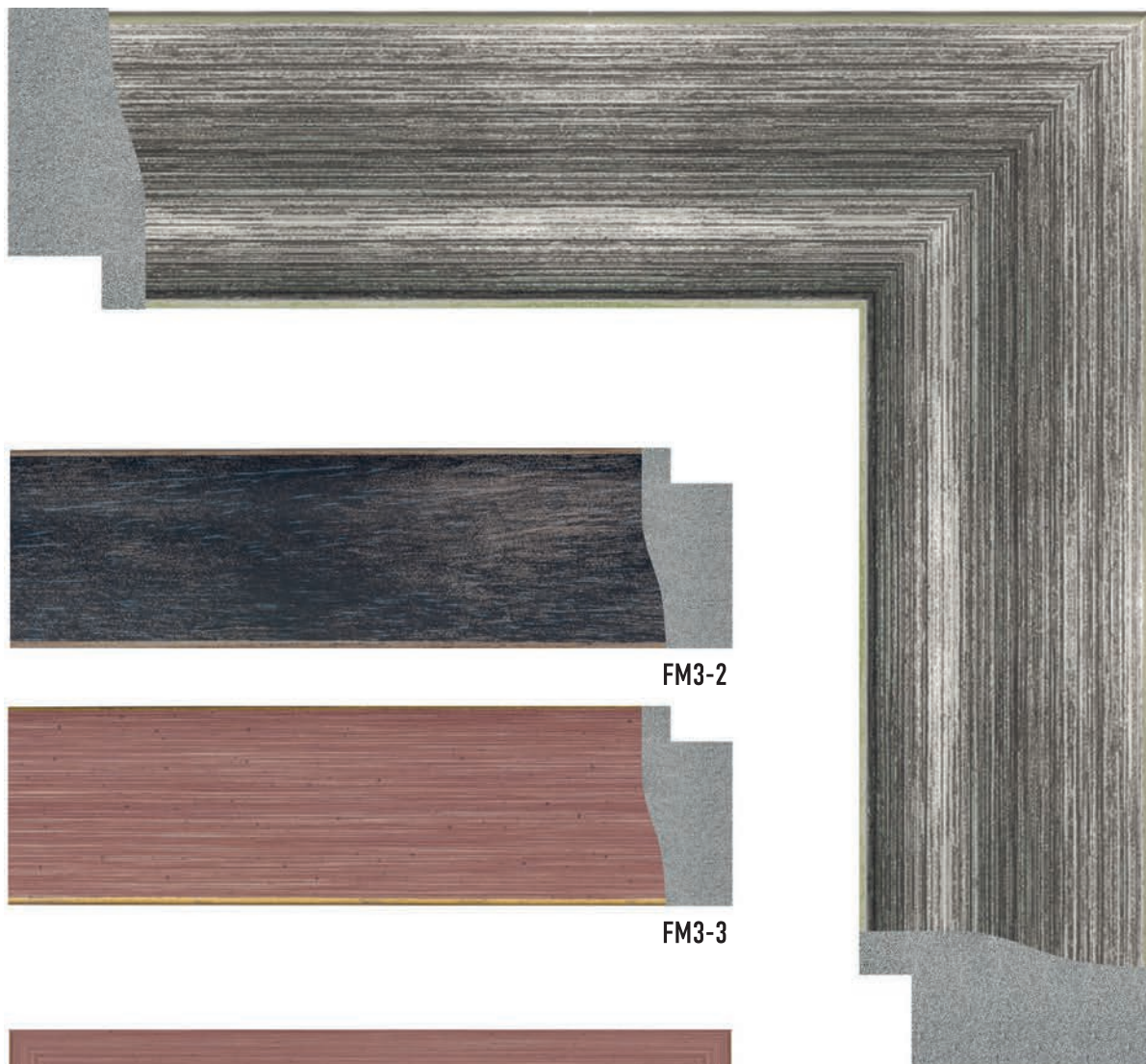

FM3-2



FM3-3



FM3-1

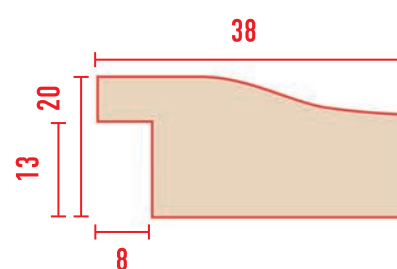



коллекция

ЭКЛЕКТИКА



FM16-1

FM16-2

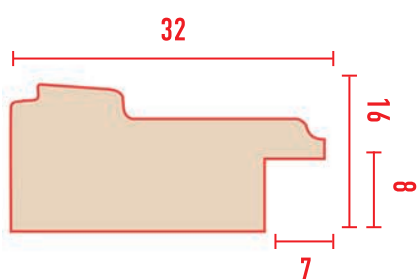

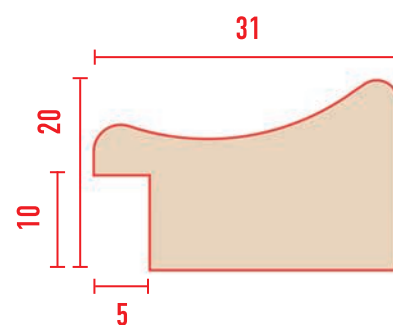
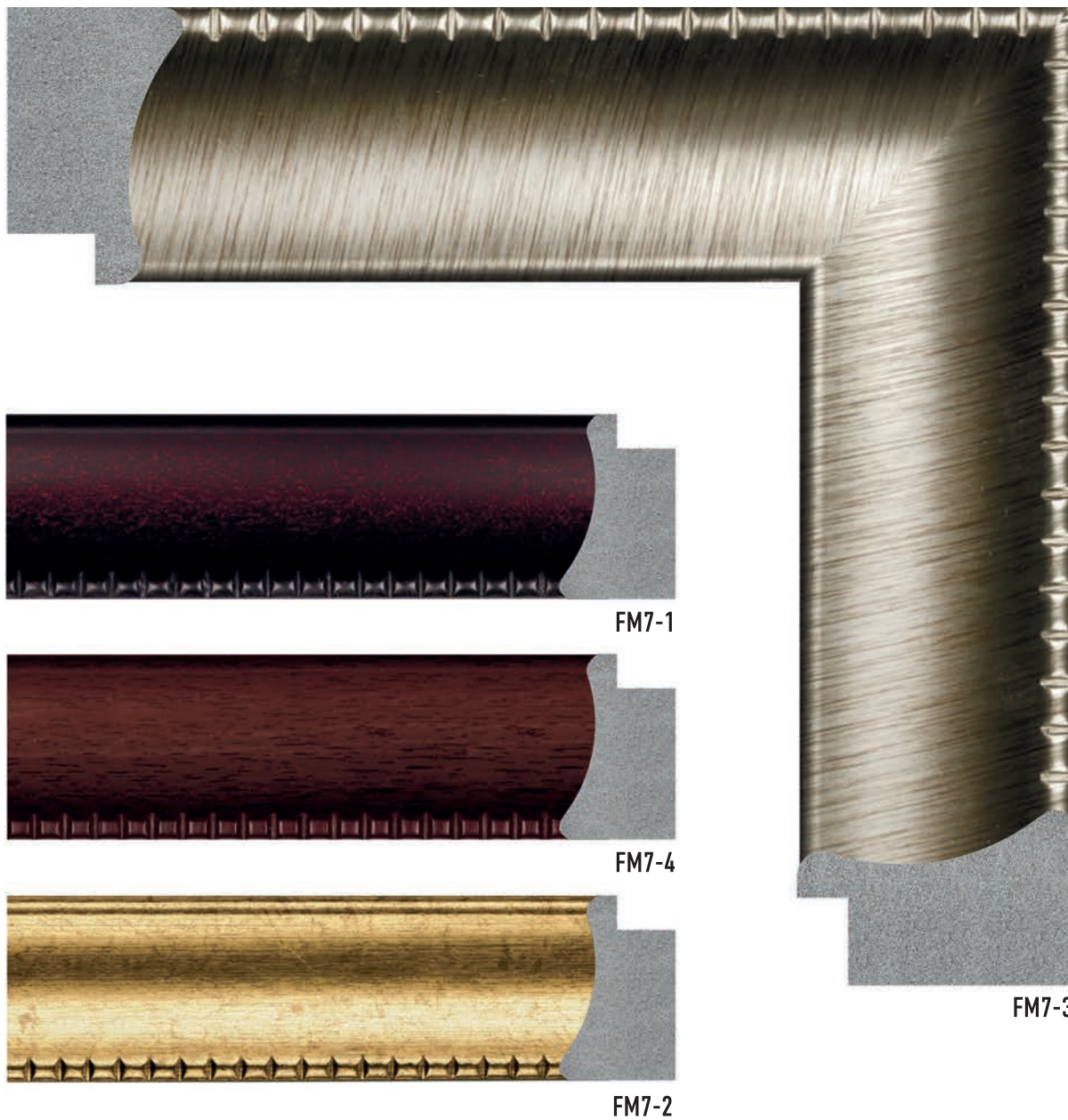



FM2-1

FM2-3

FM2-2

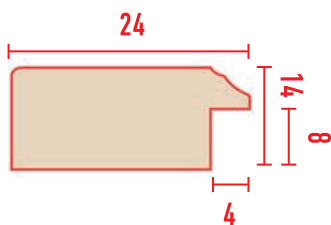

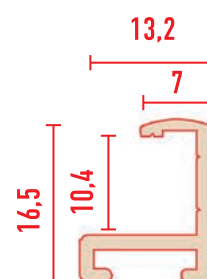
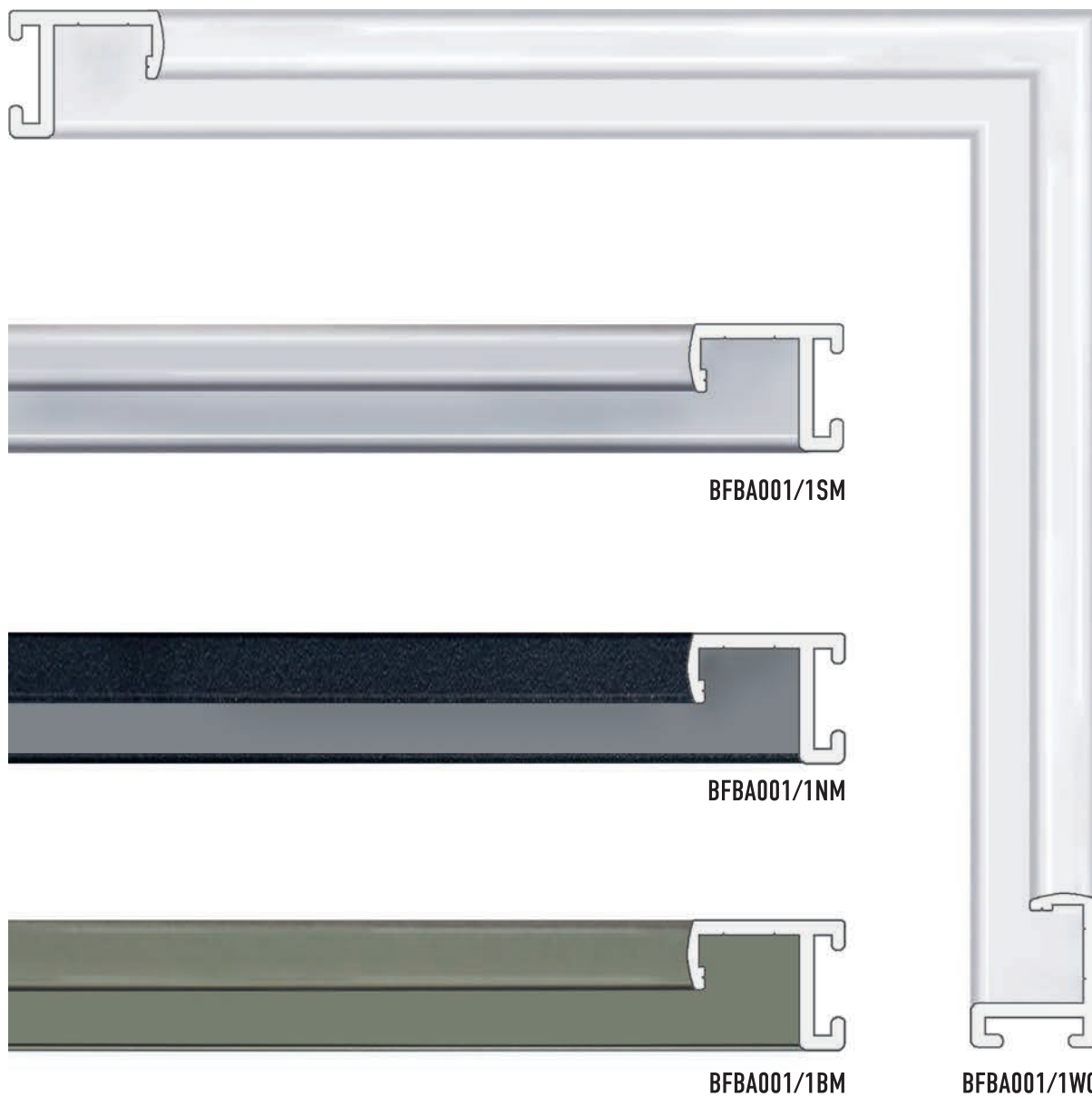



БАГЕТ ИЗ ПОЛИУРЕТАНА

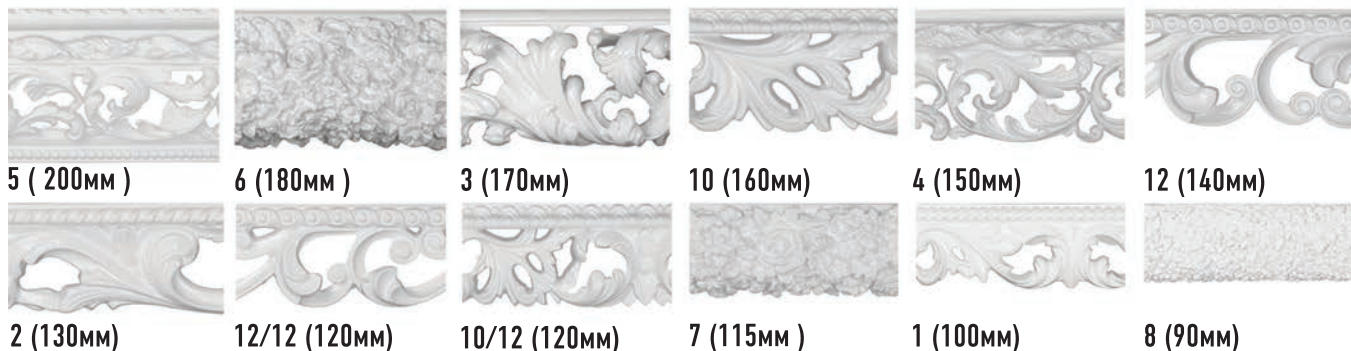



СОДЕРЖАНИЕ

Артикул	Стр.	Артикул	Стр.	Артикул	Стр.	Артикул	Стр.	Артикул	Стр.	Артикул	Стр.	Артикул	Стр.
102-15	68	158-55	70	413-566	14	556-2	49	807-4	56	BFBA001/1SM	109	FM20-2	104
102-17	69	158-552	72	413-919	14	556-4	49	807-40	58	BFBA001/1NM	109	FM21-1	91
102-18	68	158-553	72	413-1606	15	556-6	49	807-41	58	FM2-1	108	FM21-2	91
102-19	68	158-6	71	413-1607	15	564-277	66	807-42	58	FM2-2	108	FM22-1	80
102-20	68	158-7D	71	413-1608	15	564-278	66	807-43	58	FM2-3	108	FM22-2	80
102-28	69	158-767	72	413-1609	15	564-280	66	807-44	58	FM3-1	105	FM22-3	80
102-29	69	158-933	71	477-114	55	566-1606	37	807-5	56	FM3-2	105	FM22-4	80
102-51	69	158-937	71	477-1243	55	566-1607	37	807-56	57	FM3-3	105	FM23-1	99
102-52	69	159B-565	77	477-1244	55	566-1608	37	807-57	57	FM4-1	85	FM24-1	88
102-53	69	159D-552	78	477-195	55	566-1609	37	807-58	57	FM4-2	85	FM25-1	87
108-7	34	159D-553	78	516-126	21	566-1223	37	807-59	59	FM4-3	85	FM25-2	87
108-1333	34	175-1	46	516-127	21	566-1224	37	807-552	58	FM4-4	85	FM25-3	87
108-1069	34	175-2	46	516-1069	20	577-1223	36	807-553	58	FM5-1	102	FM25-4	87
108-17	35	175-3	46	516-1070	21	577-966	36	807-6	56	FM5-2	102	FM26-1	83
108-18	35	175-4	46	516-1333	20	582-26	32	807-60	59	FM5-3	102	FM26-2	83
108-19	35	175-5	46	516-767	21	582-27	32	807-63	59	FM5-4	102	FM27-1	95
108-20	35	175-6	46	524-1069	39	582-440	32	807-966	57	FM6-1	103	FM28-1	82
108-28	35	176-1	40	524-1070	39	582-433	32	807-7D	56	FM6-2	103	FM28-2	82
108-29	35	176-2	40	524-1333	39	582-438	32	808-176N	43	FM7-1	107	FM29-1	86
109-11	60	176-3	40	527-114	29	583-22	70	808-176S	43	FM7-2	107	FM29-2	86
109-13	60	176-4	40	527-1243	29	583-28	70	808-552	43	FM7-3	107	FM29-3	86
109-15	60	176-5	40	527-1244	29	583-29	70	808-553	43	FM7-4	107	FM29-4	86
109-17	61	176-6	40	527-195	29	584-1069	67	811M-905	33	FM8-1	84	FM30-1	98
109-18	61	198-11	50	527-725	29	584-1070	67	811M-906	33	FM8-2	84	FM30-2	98
109-19	61	198-14	50	528-114	53	587-70	44	829-294	41	FM9-1	81	FM30-3	98
109-20	61	214-3	12	528-1243	53	587-1604	44	829-934	41	FM9-2	81	FM30-4	98
109-28	61	214-373	12	528-1244	53	587-1604B	44	829-935	41	FM9-3	81	FM31-1	93
109-29	61	214-6	12	528-195	53	587-1605	44	849-373	18	FM9-4	81	J11-115	51
117-438	76	228-565	26	534-11	64	587-1605B	44	849-565	18	FM9-5	81	J11-1223	51
117-552	76	228-650	26	534-13	64	611-195	45	849-566	18	FM10-1	92	J11-1224	51
117-553	76	229-182	9	534-14	64	611-1607	45	849-919	17	FM10-2	92	J11-966	51
118-17	79	229-1068	9	534-15	64	611-1608	45	868-645	19	FM10-3	92	J12-1223	63
118-18	79	229-1223	8	534-51	64	611-1610	45	916-247	11	FM10-4	92	J12-1224	63
118-19	79	229-645	8	534-52	64	651-176	65	916-393	11	FM10-5	92	J12-966	63
118-20	79	229-955	8	534-53	64	651-176S	65	916-397	11	FM11-1	89	J13-1223	54
118-29	79	229-966	8	548M-440	47	685-126	62	916-461	11	FM11-2	89	J13-1224	54
119-34	74	230-70	6	552-114	22	685-127	62	919-70	30	FM12-1	100	J13-966	54
119-37	74	230-1223	6	552-1153	22	685-182	62	919-1604	30	FM12-2	100	S16-1223	5
149-954	75	230-966	6	552-195	22	685-217	62	919-1604B	30	FM14-1	90	S16-966	5
149-956	75	230-1543	6	552-373	22	685-221	62	919-1605	30	FM15-1	97	S18-1223	27
158-1	71	230-1604B	6	552D-114	25	686M-565	52	919-1605B	30	FM15-2	97	S18-1224	27
158-1028	73	230-1605B	6	552D-195	25	686M-566	52	927-252	16	FM16-1	106	S18-966	27
158-1084	72	230-1610	6	552C-114	24	690-182	38	947-565	4	FM16-2	106	S26-70	13
158-115	72	304-126	42	552C-195	24	690-198	38	947-566	4	FM17-1	96	S26-1604B	13
158-118	73	304-127	42	552B-1606	23	696-182	28	947-954	4	FM17-2	96	S26-1605B	13
158-126	73	304-566	42	552B-1607	23	696-401	28	947-956	4	FM18-1	101		
158-127	73	400-954	10	552B-1608	23	807-1	56	978-565	31	FM18-2	101		
158-281	73	400-956	10	552B-1609	23	807-1223	57	978-566	31	FM18-3	101		
158-3	71	400-958	10	553-114	48	807-18D	59	980-565	7	FM18-4	101		
158-4	71	413-182	14	553-1153	48	807-19D	59	980-566	7	FM19-1	94		
158-5	71	413-494	14	553-195	48	807-2	56	BFBA001/1WG	109	FM19-2	94		
158-54	72	413-565	14	553-373	48	807-3	56	BFBA001/1BM	109	FM20-1	104		



www.decomaster.su



@decomaster.su



#decomaster.su

2019